

Industrial Computers for Hazardous Locations

Series H

Catalog Numbers 6181X-12A2SW71DC, 6181X-00N2SW71DC, 6181X-12A2SWX1DC, 6181X-00N2SWX1DC, 6189X-MCLPS, 6189X-8GDDR3, 6189X-16GDDR3, 6189V-CFSSD8GB, 6189V-CFSSD16GB, 6189X-128GBSSD, 6189X-256GBSSD

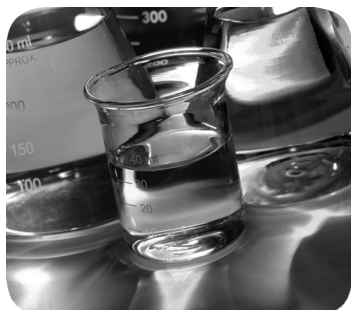

Important User Information

Read this document and the documents listed in the additional resources section about installation, configuration, and operation of this equipment before you install, configure, operate, or maintain this product. Users are required to familiarize themselves with installation and wiring instructions in addition to requirements of all applicable codes, laws, and standards.

Activities including installation, adjustments, putting into service, use, assembly, disassembly, and maintenance are required to be carried out by suitably trained personnel in accordance with applicable code of practice.

If this equipment is used in a manner not specified by the manufacturer, the protection provided by the equipment may be impaired.

In no event will Rockwell Automation, Inc. be responsible or liable for indirect or consequential damages resulting from the use or application of this equipment.

The examples and diagrams in this manual are included solely for illustrative purposes. Because of the many variables and requirements associated with any particular installation, Rockwell Automation, Inc. cannot assume responsibility or liability for actual use based on the examples and diagrams.

No patent liability is assumed by Rockwell Automation, Inc. with respect to use of information, circuits, equipment, or software described in this manual.

Reproduction of the contents of this manual, in whole or in part, without written permission of Rockwell Automation, Inc., is prohibited

Throughout this manual, when necessary, we use notes to make you aware of safety considerations.



WARNING: Identifies information about practices or circumstances that can cause an explosion in a hazardous environment, which may lead to personal injury or death, property damage, or economic loss.



ATTENTION: Identifies information about practices or circumstances that can lead to personal injury or death, property damage, or economic loss. Attentions help you identify a hazard, avoid a hazard, and recognize the consequence.

IMPORTANT

Identifies information that is critical for successful application and understanding of the product.

Labels may also be on or inside the equipment to provide specific precautions.



SHOCK HAZARD: Labels may be on or inside the equipment, for example, a drive or motor, to alert people that dangerous voltage may be present.



BURN HAZARD: Labels may be on or inside the equipment, for example, a drive or motor, to alert people that surfaces may reach dangerous temperatures.



ARC FLASH HAZARD: Labels may be on or inside the equipment, for example, a motor control center, to alert people to potential Arc Flash. Arc Flash will cause severe injury or death. Wear proper Personal Protective Equipment (PPE). Follow ALL Regulatory requirements for safe work practices and for Personal Protective Equipment (PPE).

	Preface	
	Abbreviations.....	7
	Additional Resources.....	8
	Chapter 1	
Features	Operating Systems.....	9
	Computer Options.....	9
	Computer Nameplate Information.....	10
	Hardware Features.....	11
	Chapter 2	
Install the Computer	Before You Begin.....	13
	Parts List.....	13
	Installation Precautions.....	14
	Environment and Enclosure Information.....	14
	European Union Directive.....	14
	Outdoor Installation.....	15
	Hazardous Locations.....	16
	Hot Surfaces.....	17
	Restricted Access Location.....	17
	Environnements Dangereux.....	18
	Installation Guidelines.....	19
	Mounting Clearance Requirements.....	20
	Computer Dimensions.....	21
	Tools for Computer Installation.....	22
	Install the Computer.....	22
	Panel Mounting Guidelines.....	22
	Panel Cutout Dimensions.....	22
	Mount the Display Computer in a Panel.....	23
	Mount the Non-display Computer on a Wall.....	24
	Connect Power.....	25
	Connect to a Network.....	26
	Chapter 3	
Operate the Computer	Operating Guidelines.....	27
	Touch Screen Precautions.....	28
	Start the Computer.....	28
	Restart the Computer.....	29
	Shut Down the Computer.....	29
	Adjust the Display Brightness.....	29

Replace Components

Chapter 4

Accessories and Replacement Parts 31
 Voltage Precautions 31
 Electrostatic Discharge Precautions 32
 Pre-configuration 32
 Post-configuration 33
 Tools for Component Replacement..... 33
 Remove the Cover..... 33
 Reinstall the Cover 34
 Replace a Solid-state Drive 35
 Load a CompactFlash Card 36
 Install an Add-in Card..... 37
 Replace or Add Memory Modules 38
 Memory Configuration Guidelines..... 38
 Replace or Add a Memory Module..... 39
 Real-time Clock (RTC) Battery 39

Set Up the UEFI Utility

Chapter 5

Set-up Utility Overview..... 41
 Access the Set-up Utility..... 42
 Set-up Screen Overview..... 42
 Firmware Update 43
 Firmware Configuration..... 44
 Main 45
 Advanced..... 46
 Chipset 51
 Boot..... 52
 Security..... 53
 Save and Exit..... 53
 Diagnostics 54
 AMI Rescue 55
 Make a Backup..... 56
 Restore OS Image From a Hidden Partition 57
 Restore OS Image From a USB Storage Drive..... 60
 Hardware History..... 64
 Exit 65
 Upgrade to a New UEFI..... 66

Troubleshoot the System	Chapter 6	
	Hardware Monitoring	67
	Troubleshooting	68
	Diagnostics	68
	Load the System Defaults	69
	Clear the CMOS	70
	Ship or Transport the Computer	71
Dispose of the Computer	71	
Use a Touch Screen	Chapter 7	
	Touch Screen Technology	73
	Driver Software	73
	Resistive Touch Screen Technology.....	73
	Calibrate the Touch Screen	74
Maintain the Computer	Chapter 8	
	Clean the Computer	75
	Clean the Integrated Display	75
	Clean the Heat Sink and Vent Holes	75
	Remove Paint and Grease from the Bezel	76
	RTC Battery.....	76
	Index	
	77

Notes:

This manual is a user guide for 6181X Series H display and non-display industrial computers for hazardous locations. It provides procedures to the following:

- Install the computer.
- Make computer connections.
- Operate the computer.
- Troubleshoot the computer.

Abbreviations

This publication uses the following abbreviations.

Abbr	Meaning
BIOS	Basic input/output system
CF	CompactFlash
CMOS	Complementary metal oxide semiconductor
COM	Communication (serial port interface)
DDR	Double data rate (RAM)
DIMM	Dual in-line memory module
DP	DisplayPort (digital display interface)
DVI	Digital video interface
EEA	European Environment Agency
EMC	Electromagnetic compatibility
ESD	Electrostatic discharge
IEC	International Engineering Consortium
LAN	Local area network
NDM	Non-display model
NEMA	National Electrical Manufacturers Association
PCAP	Protective capacitive (touch screen)

Abbr	Meaning
PCB	Printed circuit board
PCDC	Product Compatibility and Download Center
PCI	Peripheral component interconnect
PCIe	Peripheral component interconnect express
PELV	Protective extra-low voltage
POST	Power on self-test
RAM	Random access memory
RTC	Real-time clock
SELV	Safety extra-low voltage
SSD	Solid-state drive
TFT	Thin film transistor
UEFI	Universal extensible firmware interface
USB	Universal serial bus
UPS	Uninterruptible power source
VGA	Video graphics array

Additional Resources

These documents contain additional information to related products from Rockwell Automation.

Resource	Description
Industrial Computer and Monitor Specifications Technical Data, publication IC-TD001	Provides technical specifications for the 6181X integrated display and non-display computers for hazardous locations.
6181X Industrial Computers for Hazardous Locations, Series H, Installation Instructions, publication 6181X-IN002	Provides procedures to install the 6181X Series H computer and to make connections.
Industrial Automation Wiring and Grounding Guidelines, publication 1770-4.1	Provides general guidelines to install a Rockwell Automation industrial system.

You can view or download publications at <http://www.rockwellautomation.com/global/literature-library/overview.page>. To order paper copies of technical documentation, contact your local Allen-Bradley® distributor or Rockwell Automation sales representative.

Features

Topic	Page
Operating Systems	9
Computer Options	9
Computer Nameplate Information	10
Hardware Features	11

Operating Systems

The following Microsoft-licensed operating systems are available:

- Windows 7 Professional (64 bit), SP 1
- Windows 10 IoT Enterprise (64 bit)

To obtain a copy of a factory system image, contact your local technical-support center or access the Rockwell Automation Product Compatibility and Download Center (PCDC) at <http://compatibility.rockwellautomation.com/Pages/home.aspx>.

Computer Options

[Table 1](#) summarizes the options that are available for industrial computers for hazardous locations.

Table 1 - Computer Options

Cat. No.	Model	Series	Display Size	Touch Screen	Windows OS
6181X-00N2SW71DC	NDM	H	N/A	N/A	7 Professional 64 bit SP1
6181X-12A2SW71DC	1200P		12.1 in.	Resistive	
6181X-00N2SWX1DC	NDM		N/A	N/A	10 IoT Enterprise 64 bit
6181X-12A2SWX1DC	1200P		12.1 in.	Resistive	

This table summarizes the accessories that are available for industrial computers for hazardous locations.

Table 2 - Available Accessories

Cat. No.	Description
6189X-MCLPS	Replacement mounting clips (10)
6189X-8GDDR3	8 GB DDR3 RAM memory for extended temperature
6189X-16GDDR3	16 GB DDR3 RAM memory for extended temperature
6189V-CFSSD8GB	CompactFlash card, 8 GB single-level cell (SLC) solid-state drive (SSD)
6189V-CFSSD16GB	CompactFlash card, 16 GB SLC SSD
6189X-128GBSSD	128 GB multi-level cell (MLC) SSD
6189X-256GBSSD	256 GB MLC SSD

You can view a current list of accessories and replacement parts at <http://ab.rockwellautomation.com/Computers/Hazardous-Location-Display-Computers#selection>.

Computer Nameplate Information

The computer catalog number, serial number, and date code are on its nameplate.

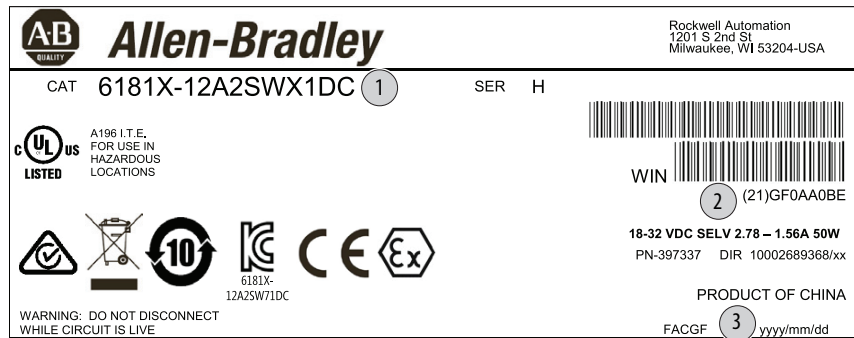

Record the following information in this table for future reference.

1	Catalog number	
2	WIN/serial number	
3	Date code	

Hardware Features

Figure 1 shows the hardware features of the industrial computers for hazardous locations.

Figure 1 - Industrial Computer for Hazardous Locations

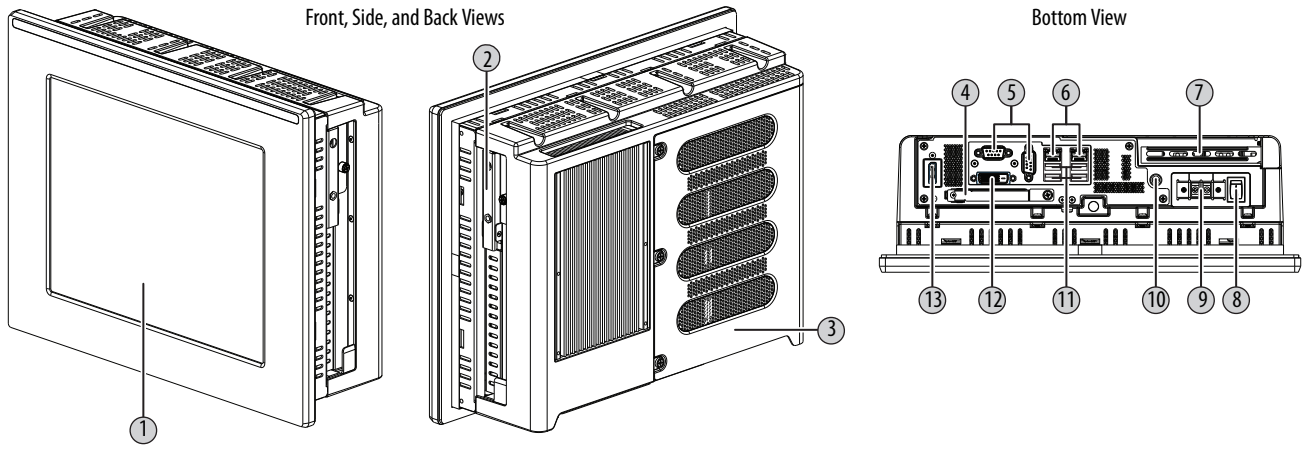

Item	Component
1	LCD panel (only on display model)
2	128 GB MLC SSD
3	Rear cover
4	CompactFlash (CF) Type II card slot ⁽¹⁾

Item	Component
5	Serial COM ports (RS-232), 2
6	1 Gb LAN ports (RJ45), 2
7	PCIe riser slot cover
8	Power switch
9	DC input terminal block

Item	Component
10	Functional ground screw
11	USB 3.0 ports, 4 ⁽¹⁾
12	DVI-D port
13	DisplayPort

(1) The USB ports and the bottom CF card slot are hot swappable but only in non-hazardous locations. For more information about proper use of these ports, refer to [Hazardous Locations on page 16](#).

Notes:

Install the Computer

Topic	Page
Before You Begin	13
Parts List	13
Installation Precautions	14
Environnements Dangereux	18
Installation Guidelines	19
Mounting Clearance Requirements	20
Computer Dimensions	21
Tools for Computer Installation	22
Install the Computer	22
Connect Power	25
Connect to a Network	26

Before You Begin

Before you unpack the computer, inspect the shipping carton for damage. If damage is visible, immediately contact the shipper and request assistance. Otherwise, continue to unpack.

Keep the original packing material in case you must return the computer for repair or transport it to another location. Use both inner and outer packing cartons to provide adequate protection for a computer that is returned for service.

Parts List

The computers ship with these items.

Item	Description
Hardware	<ul style="list-style-type: none"> Screws with grommets to mount non-display computers Clips to mount display computers
Documents	<ul style="list-style-type: none"> 6181X Industrial Computers for Hazardous Locations, Series H, Installation Instructions, publication 6181X-IN002 6181P and 6181X Industrial Computers Cutout Template, publication 6181P-DS002⁽¹⁾ Production test report

(1) Shipped only with display computers.

Installation Precautions

Read and follow these precautions before you install the computer.

Environment and Enclosure Information



ATTENTION: This equipment is intended for use in a Pollution Degree 2 industrial environment, in overvoltage Category II applications (as defined in IEC 60664-1), at altitudes up to 2000 m (6561 ft) without derating.

This equipment is considered Group 1, Class A industrial equipment according to IEC/CISPR 22. Without appropriate precautions, there can be potential difficulties with electromagnetic compatibility in other environments due to conducted as well as radiated disturbance.

This equipment is supplied as an open type equipment. To meet some regulatory requirements, the computer must be mounted in an enclosure that is suitably designed for environmental conditions that can be present and appropriately designed to help prevent personal injury resulting from accessibility to live parts. The interior of the enclosure must be accessible only by using a tool.

All 6181X-12 display computers are shipped with a gasketed bezel to meet specified NEMA, UL Type, and IEC ratings only when mounted in a panel or enclosure with an equivalent rating.

In addition to this publication, see the following:

- Industrial Automation Wiring and Grounding Guidelines, publication [1770-4.1](#), for additional installation requirements
- NEMA 250, UL 50, and IEC 60529, as applicable, for explanations of the degrees of protection that are provided by enclosures

European Union Directive

This computer meets the European Union Directive requirements when installed within the European Union or EEA regions and have the CE mark. A copy of the declaration of the conformity is available at <http://www.rockwellautomation/certification>.



ATTENTION: To comply with EN 55024 and EN 55032, all I/O cables must be less than 30 m (98.42 ft) and only used indoors. These cables cannot exit the building at any point and cannot directly connect to cables outside the building.

To comply with EN 55024 and EN 55032, use the following for cable types.

Cable Type	Required Attribute
LAN	Shielded or unshielded
USB	Shielded
Serial RS-232	Shielded
DVI	Shielded

Cable Type	Required Attribute
DP	Shielded
VGA	Shielded
DC power	Unshielded

Outdoor Installation

When you use a 6181X display computer outdoors, consider the following to maximize the field life of the front bezel and display:

- Select the proper enclosure
- Computer orientation

Ultraviolet (UV) and infrared radiation can reduce the field life of any electronic device. While the materials used in the computer bezels provide long field life, that life can be improved by proper installation.

UV radiation from the sun causes all plastics to fade or yellow and become brittle over time. Avoiding long-term exposure to direct sunlight helps protect the front of the computer from direct exposure to UV radiation, and greatly increase its field life.

If you install a sun shield that closes over the display, the temperature between the sun shield and the display cannot exceed the maximum temperature of the display, which is 55 °C (131 °F). Adequately ventilate all sun shields to help prevent excess heat rise on the computer display.



Use stirring fans or active cooling in high altitude and high ambient temperature locations to keep the internal enclosure temperature below 70 °C (158 °F). Use a heater in installations where the ambient temperature is below -20 °C (-4 °F).

If possible, avoid placing the computer on the south (north in the southern hemisphere) or west side of the cabinet. This reduces the heat rise due to solar loading during the hottest part of the day.

Mount the computer vertically to minimize solar loading on the display. Do not mount the computer in a sloped enclosure if it exposes the computer to direct sunlight.

Hazardous Locations

This equipment is suitable for these location categories.

Computer Model	Cat. Nos.	Region	Rating	Temperature Range
Non-display ⁽¹⁾	6181X-00N2SW71DC, 6181X-00N2SWX1DC	United States	Class I Division 2, Groups A, B, C, D T4	-20 °C ≤ T _a ≤ 70 °C ⁽³⁾ (-4 °F ≤ T _a ≤ 158 °F)
			Class I Zone 2, IIC, T4	
		Canada	Class I Division 2, Groups A, B, C, D T4	
			Class I Zone 2, IIC, T4	
Europe (ATEX)	 II 3 G, Ex nA IIC T4 Gc, DEMKO 17 ATEX 1851 X			
Global/IECEx	Ex nA IIC T4 Gc, IECEx UL 17.0024 X			
Display (12 in.) ⁽²⁾	6181X-12A2SW71DC, 6181X-12A2SWX1DC	United States	Class I Division 2, Groups A, B, C, D T4	-20 °C ≤ T _a ≤ 55 °C (-4 °F ≤ T _a ≤ 131 °F) (display side)
			Class I Zone 2, IIC, T4	
		Canada	Class I Division 2, Groups A, B, C, D T4	-20 °C ≤ T _a ≤ 70 °C (-4 °F ≤ T _a ≤ 158 °F) (backside) ⁽³⁾
			Class I Zone 2, IIC, T4	
Europe (ATEX)	 II 3 GD, Ex nA nC IIC T4 Gc IP66, Ex tc IIIC T135 °C Dc IP66, DEMKO 17 ATEX 1851 X			
Global/IECEx	Ex nA nC IIC T4 Gc IP66, Ex tc IIIC T135 °C Dc IP66, IECEx UL 17.0024 X			

(1) The following applies only to non-display models (6181X-00N2SW71DC and 6181X-00N2SWX1DC):

- The equipment shall only be used in an area of not more than pollution degree 2, as defined in EN/IEC 60664-1.
- The equipment shall be installed in an enclosure that provides a degree of protection not less than IP54 in accordance with EN/IEC 60079-15 and EN/IEC 60079-0.
- Transient protection shall be provided that is set at a level not exceeding 140% of the peak rated voltage value at the supply terminals to the equipment.
- The USB ports have not been evaluated as nonincendive field wiring.
- The internal enclosure ambient temperature range is -20...+70 °C (-4...+158 °F).

(2) The following applies only to display models (6181X-12A2SW71DC and 6181X-12A2SWX1DC):

- The equipment shall only be used in an area of not more than pollution degree 2, as defined in EN/IEC 60664-1.
- For EPL Gc, the equipment shall be installed in an enclosure that provides a degree of protection not less than IP54 in accordance with EN/IEC 60079-15 and EN/IEC 60079-0.
- For EPL Dc, the equipment shall be installed in an enclosure that provides a degree of protection not less than IP 64 in accordance with EN/IEC 60079-31, EN/IEC 60079-15 and EN/IEC 60079-0.
- Transient protection shall be provided that is set at a level not exceeding 140% of the peak rated voltage value at the supply terminals to the equipment.
- The USB ports have not been evaluated as nonincendive field wiring.
- The ambient temperature (external to enclosure) range is -20...+55 °C (-4...+131 °F), and that of the internal enclosure ambient temperature is -20...+70 °C (-4...+158 °F).
- To maintain the IP66 rating of the equipment, it shall be installed in an enclosure with an equivalent IP rating.

(3) The entire non-display computer and the backside of the display computer are required to be mounted in a restricted access location.

Power Specifications

Attribute	6181X Non-display Models	6181X Display Models
Input voltage	18...32V DC	
Power consumption, DC (max)	18...32V DC (SELV), 2.46...1.34 A, 45 W	18...32V DC (SELV), 3.28...1.79 A, 60 W
Heat dissipation ⁽¹⁾	45 W (154 BTU/h)	60 W (205 BTU/h)
Ratings, max		
USB ports, per port	900 mA, 10 W max for all ports (2 A)	
PCIe slot	4 W	

(1) Add-in cards and peripherals are included in the heat dissipation value.

The following statement applies to when the computer is used in a hazardous location.

**WARNING: Explosion Hazard**

- Substitution of components can impair suitability for hazardous locations.
 - Do not disconnect equipment unless power has been switched off and the area is known to be non-hazardous.
 - Do not connect or disconnect components unless power has been switched off.
 - Peripheral equipment must be suitable for the location where it is used.
 - In the U.S., all wiring must be in accordance with Class I, Division 2 wiring methods of Article 501 of the National Electrical Code, and in accordance with the authority having jurisdiction.
 - In Canada, all wiring must be in accordance with Section 18-1J2 of the Canadian Electrical Code, and in accordance with the authority having jurisdiction.
 - For European Zone 2 and IECEx applications:
 - Transient protection shall be provided that is set at a level not exceeding 140% of the peak rated voltage value at the supply terminals to the equipment.
 - Non-display computers must be installed in a Pollution Degree 2 environment and fully mounted within an enclosure rated IP54 minimum.
 - The USB ports have not been evaluated as nonincendive field wiring.
 - For European Zone 2 (gases) and IECEx applications, computers with displays must be installed in a Pollution Degree 2 environment and mounted through the wall or door of an enclosure rated IP54 minimum.
 - For European Zone 22 (dusts) and IECEx applications, computers with displays must be installed in a Pollution Degree 2 environment and mounted through the wall or door of an enclosure rated IP6x minimum. Computers with displays support enclosures rated up to IP66.
 - In final applications, properly connect these devices to ground by using the ground terminal screw on the computer chassis.
-

Hot Surfaces

ATTENTION: When used above 50 °C (122 °F), the backside of display computers and entire non-display computers must be installed in a restricted access location.

Restricted Access Location

Verify that restricted access locations for the equipment meet these conditions:

- Access is gained only by service personnel or by users who have been instructed on the reasons for restrictions to a location and about any precautions to be taken.
- Access is by using a tool, a lock and key, or other means of security controlled by the authority responsible for the location.

Environnements Dangereux



ATTENTION: This page is a French translation of portions of the [Hazardous Locations](#) section to comply with certification agency requirements.

Cet équipement peut être utilisé dans les environnements suivants :

- Classe I, Division 2, Groupes A, B, C, et D
- non dangereux

La mise en garde suivante s'applique à une utilisation en environnement dangereux.



ATTENTION: Danger d'explosion

- La substitution de composants peut rendre cet équipement impropre à une utilisation en environnement dangereux.
 - Ne pas déconnecter l'équipement sans s'être assuré que l'alimentation est coupée et que l'environnement est classé non dangereux.
 - Ne pas connecter ou déconnecter des composants sans s'être assuré que l'alimentation est coupée.
 - L'ensemble du câblage doit être conforme à la réglementation en vigueur dans le pays où cet équipement est installé.
 - L'équipement périphérique doit être adapté à l'environnement dans lequel il est utilisé.
 - Tout équipement utilisé en environnement dangereux doit être monté dans une armoire fournissant une protection adaptée aux conditions d'utilisation ambiantes et suffisante pour éviter toute blessure corporelle pouvant résulter d'un contact direct avec des composants sous tension.
-

Les ordinateurs ont un code de température T4 (135 °C) lorsqu'ils fonctionnent dans les températures ambiantes maximales suivantes. Voir également le graphique Directives d'installation en [page 19](#) de ce document.

- 6181X-12.....55 °C en face avant de l'écran et 70 °C en face arrière, en cas de montage comme prévu au travers de la paroi d'un coffret.
- 6181X-N.....70 °C au maximum, en cas de montage comme prévu à l'intérieur d'un coffret.

N'installez pas l'ordinateur dans des environnements atmosphériques explosifs (par ex. du gaz) dont la température d'inflammabilité est inférieure à 135 °C.

Installation Guidelines

Follow these guidelines to make sure that your computer provides service with excellent reliability:

- The installation site must have sufficient power.
- In dry environments, static charges can build up easily. Proper grounding of the computer helps to reduce static discharges, which can cause shock and damage electronic components.
- The enclosure must allow sufficient space around air inlets and outlets to provide the circulation necessary for cooling. See [Mounting Clearance Requirements on page 20](#) for further information. Never allow air passages to become obstructed.
- The ambient air temperature must not exceed the maximum operating temperature as follows:
 - Non-display computers: $-20\dots+70\text{ }^{\circ}\text{C}$ ($-4\dots+158\text{ }^{\circ}\text{F}$)
 - Display computers: $-20\dots+55\text{ }^{\circ}\text{C}$ ($-4\dots+131\text{ }^{\circ}\text{F}$), display side
 $-20\dots+70\text{ }^{\circ}\text{C}$ ($-4\dots+158\text{ }^{\circ}\text{F}$), back side

Consider a user-supplied fan, heat exchanger, or air conditioner for heat that is generated by other devices in the enclosure.

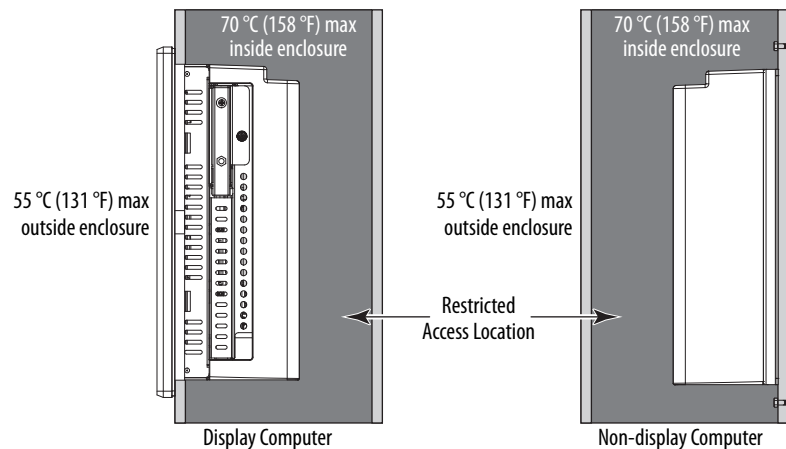

TIP Hot air rises. The temperature at the top of the enclosure is often higher than the temperature in other parts of the enclosure, which is likely if air is not circulating.

IMPORTANT The computer can operate at a range of extremes. If you continuously operate the computer at its highest rated temperature, then the life span of any electronic device is shortened, which includes the touch screen and LCD panel.

- The relative humidity of the ambient air must be between 10...90% and must avoid condensation.
- The enclosure or cover must always remain in place during operation. The cover provides protection against high voltages inside the computer and inhibits radio-frequency emissions that can interfere with other equipment.

- When mounted, the computer cannot be tilted from vertical.

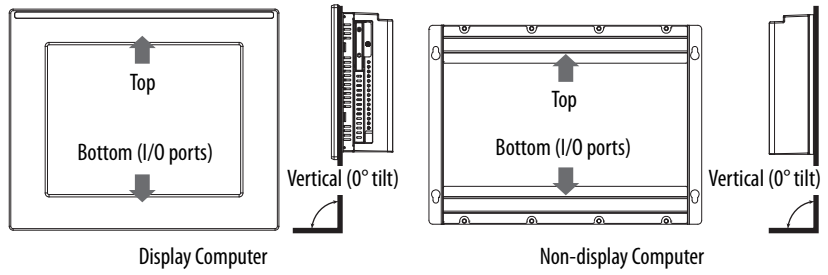

Mounting Clearance Requirements

IMPORTANT

Because of self-heating, do not operate the computer in an enclosure by using the minimum clearances unless adequate ventilation or other methods are used to lower the temperature within the enclosure.

Allow enough clearance to install or remove peripheral components, such as internal drives.

The minimum required enclosure size (HxWxD) is 403 x 497 x 154 mm (15.87 x 19.57 x 6.06 in.).

Figure 2 - Minimum Clearances (display model shown)

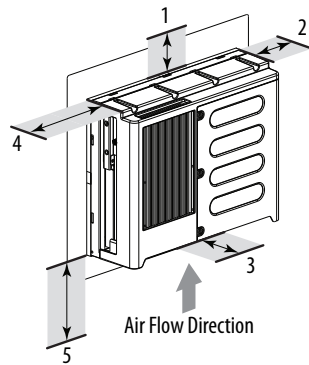

Item	Description	Clearance, min
1	Top	50 mm (2 in.)
2	Right (for airflow)	50 mm (2 in.)
3	Rear	50 mm (2 in.)
4	Left (for airflow and drive access)	127 mm (5 in.)
5	Bottom (for I/O port access and ventilation)	102 mm (4 in.)

Right and left are based on facing a computer from inside an enclosure.

Computer Dimensions

Review computer dimensions to estimate the clearance necessary for computer installation.

Figure 3 - Non-display Computers

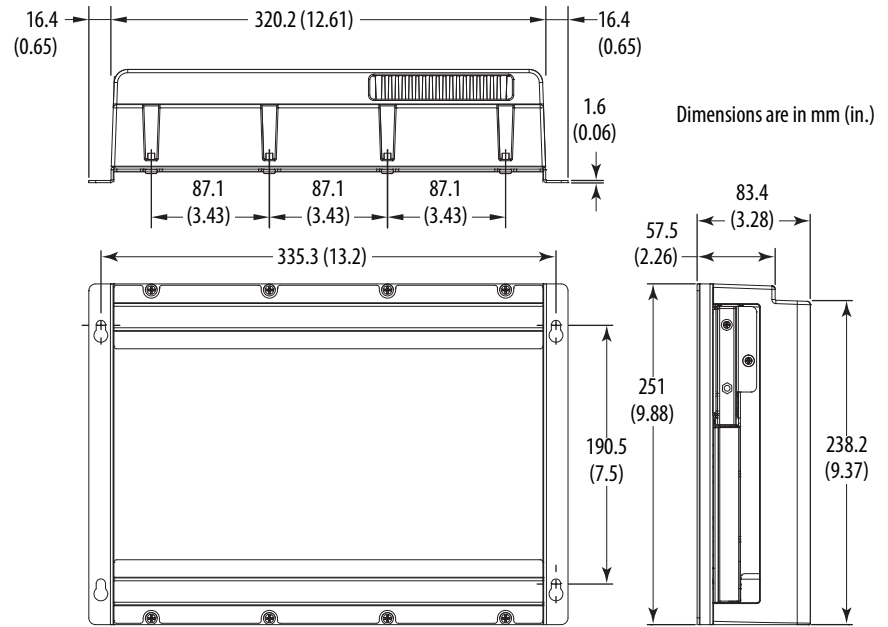
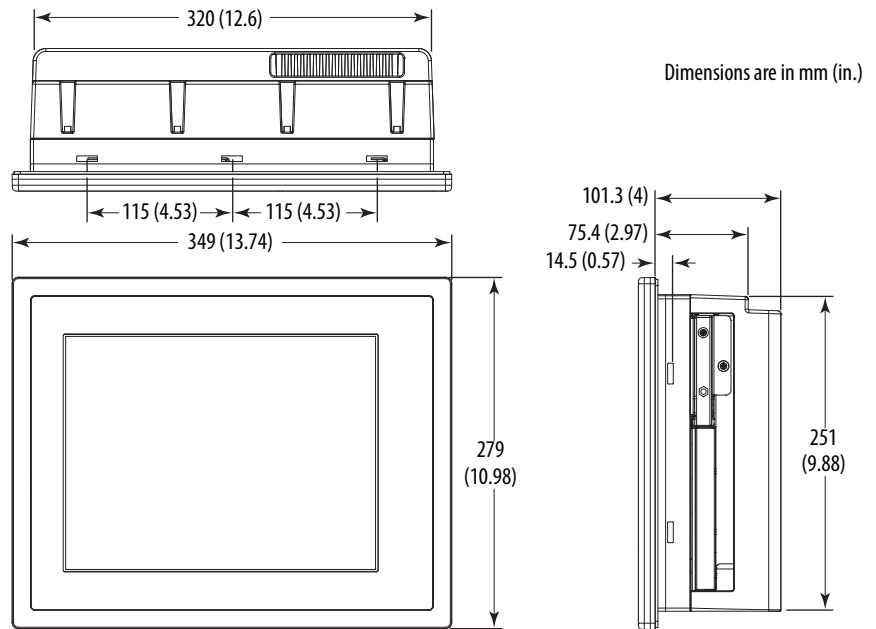

Figure 4 - Integrated Display Computers



Tools for Computer Installation

These tools are required for computer installation:

- #2 cross-head screwdriver
- Panel cutout tools (for panel mounting)
- Drill motor, drill bit, and M4 screw tap (for wall mounting)
- Anti-static wriststrap

Install the Computer

The computers support these mounting options:

- Panel mount (display computer models)
- Wall mount (non-display computer models)

Panel Mounting Guidelines

Observe these guidelines when you install the computer in a panel:

- Remove all electrical power from the panel before making the cutout.
- Verify that there is adequate space behind the panel. For specific information, see [Mounting Clearance Requirements on page 20](#).
- Cut support panels to specifications before installation. Take precautions so metal cuttings do not enter components that are already installed in the panel.

Support panels must be at least 16 gauge for proper sealing against water and dust, and to provide proper support. The supplied mounting hardware accommodates panel thickness between 16...6 gauge or 1.6...6 mm (0.064...0.24 in.). Make sure the area around the panel cutout is clear.



ATTENTION: Failure to follow these guidelines can result in personal injury or damage to the panel components.

Panel Cutout Dimensions

The 6181P and 6181X Industrial Computers Cutout Template, publication [6181P-DS002](#), is shipped with all 6181X integrated display computers.

The display computers must be mounted to meet these panel cutout dimensions.

Cat. Nos.	Cutout Dimensions (H x W), approx
6181X-12A2SW71DC 6181X-12A2SWX1DC	254 x 324 mm (10 x 12.76 in.)

Mount the Display Computer in a Panel

Use the supplied clips to secure the display computer to the panel.

Cat. Nos.	Clips (qty.)	Cat. No.	Description
6181X-12A2SW71DC 6181X-12A2SWX1DC	10	6189X-MCLPS	Replacement mounting clips (10)

Follow these steps to mount the computer in a panel.

1. Remove power from the panel.
2. Verify that the panel surface around the area to be cut is clean and free of debris.



ATTENTION: Take precautions so metal cuttings do not enter components that are already installed in the panel to avoid personal injury or damage to the panel components.

3. Cut an opening in the panel by using the appropriate panel cutout dimensions.
4. Make sure the sealing gasket is properly positioned on the computer.
This gasket forms a compression-type seal. Do not use sealing compounds.
5. Place the computer in the panel cutout.
6. Slide the clips into the holes on the top, bottom, and sides of the computer.
7. Hand-tighten the clips around the bezel by following this tightening sequence.

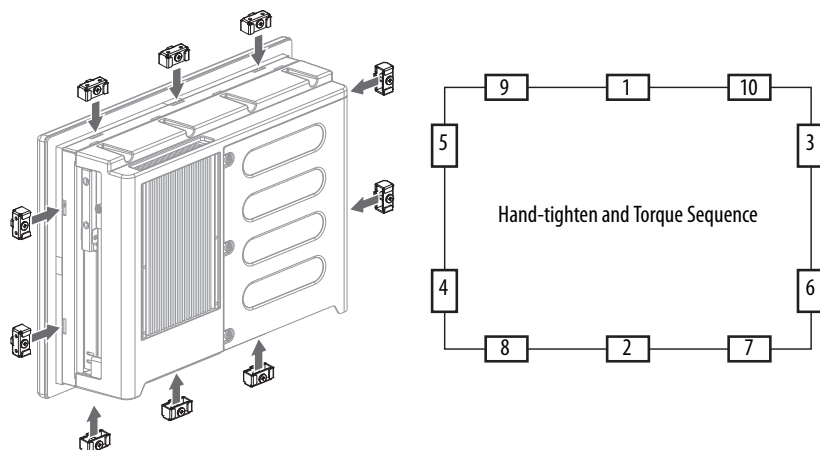

8. Repeat this process at least three times until the clips are hand-tight and the gasket is compressed uniformly against the panel.
9. Tighten the clips to a torque of 1.35 N•m (12 lb•in) by following the above torque sequence, making sure to not overtighten.

- Repeat this process at least three times until the clips are properly torqued, making sure the gasket is compressed uniformly against the panel.



ATTENTION: Tighten the clips to the specified torque to provide a proper seal and to help prevent damage to the computer. Rockwell Automation assumes no responsibility for water or chemical damage to the computer or other equipment within the enclosure because of improper installation.

Mount the Non-display Computer on a Wall

Use the four supplied screws to secure the non-display computer to a metal wall, such as a steel panel in an enclosure or equipment room.

IMPORTANT Do not mount the non-display computer on a horizontal surface.

Follow these steps to mount a non-display computer.

- Verify that the power is disconnected.
- After you decide where to mount the computer, drill holes in the wall to accommodate the four supplied M4 panhead screws.

The illustration shows the mounting hole locations with dimensions in mm (in.).

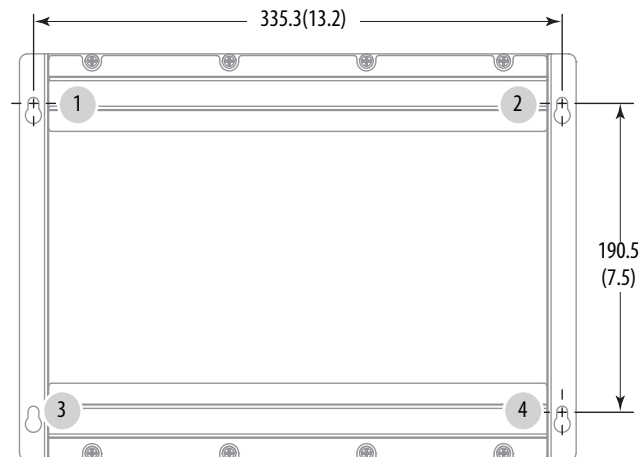

- Attach two of the supplied screws with grommets to positions **1** and **2**.
- Mount the computer to the wall.
- Attach the remaining two supplied screws with grommets to positions **3** and **4**.
- Tighten to a torque that is appropriate for the screw and wall material.

The recommended torque in steel is 1.13...1.36 N•m (10...12 lb•in).

Connect Power

Display and non-display computers have a DC input terminal block for connection to an 18...32V DC power source.



ATTENTION: When you connect power to the computer for the first time, these actions occur:

- The default BIOS setting automatically starts the computer after it is plugged into a power source.
- You must read and accept an End User Setup procedure for computers with a Windows operating system.

Do not disconnect power from the system until after the Windows Setup procedure is completed. Disconnected power during this procedure can result in a corrupted system image.

Operate the computer in an industrial or control room environment, which uses some form of power isolation from the public low-voltage mains.



ATTENTION: Supply the computer circuit with its own disconnect. Use an uninterruptible power source (UPS) to help protect against unexpected power failure or power surges.

Always shut down the Windows operating system before you disconnect power to the computer to minimize performance degradation and operating system failures.

The DC power option supports operation from safety extra-low voltage (SELV) power source.

The power supply is internally protected against reverse polarity.



ATTENTION: Use a SELV isolated and ungrounded power supply as input power to the computer. This power source provides protection so that under normal and single fault conditions, the voltage between the conductors and Functional Earth/Protective Earth does not exceed a safe value.

IMPORTANT A functional ground connection is required for EMC compliance.

Follow these steps to connect the computer to a DC power source.

1. Turn off the main power switch or breaker.
2. Verify that the DC power wires meet these requirements:
 - Material: Stranded copper, insulation 90 °C (194 °F) min
 - Wire gauge: 0.823...2.08 mm² (18...14 AWG)
3. Secure the DC power wires to the terminal block screws.

Tighten the terminal block screws to a torque of 1.36 N•m (12 lb•in).

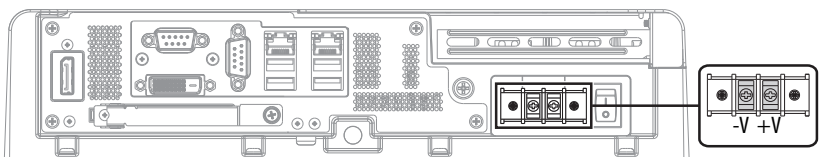

- Secure the ground wire to the functional ground screw by using a ring connector.

Tighten the functional ground screw to a torque of 1.47 N•m (13 lb•in).

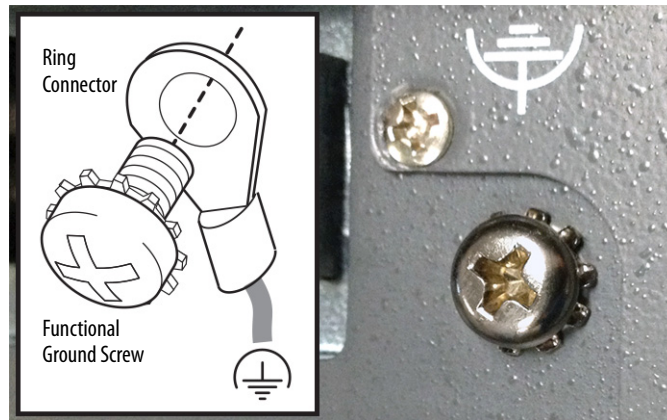

IMPORTANT When using the functional ground screw, connect the computer to earth ground by using a 1.5 mm² (16 AWG) or larger external wire. Use a ground wire with an insulation color allowed by local inspection authority.

- Apply 18...32V DC power to the computer.

Connect to a Network

The computers have two 1 Gb LAN ports. The computers connect to an EtherNet/IP network by using CAT5 or better twisted-pair Ethernet cable with RJ45 connectors.

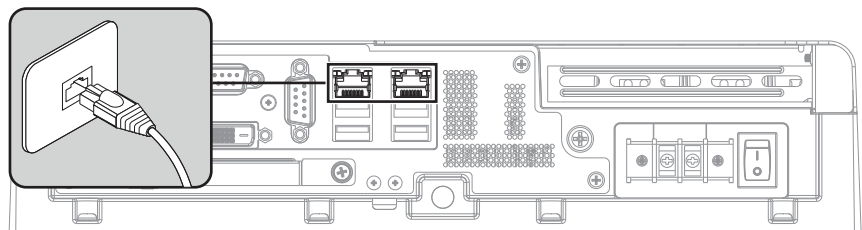

WARNING: When you connect a LAN cable, verify that the cable is fully inserted in the LAN port and the latch is engaged. Failure to do so can result in an electrical arc that can cause an explosion in a hazardous location.

IMPORTANT To help prevent performance degradation of Ethernet communication, do not subject the computer or cables to extreme radiation or conducted high-frequency noise.

In industrial environments, proper cable routing and power conditioning are required for Ethernet communication. We recommend that you route all Ethernet cable through dedicated metal conduits. For improved performance reliability, install ferrite bead filters at the cable ends.

Operate the Computer

Topic	Page
Operating Guidelines	27
Touch Screen Precautions	28
Start the Computer	28
Restart the Computer	29
Shut Down the Computer	29
Adjust the Display Brightness	29

Operating Guidelines

Follow these operating guidelines for your computer:

- When the computer is panel mounted, operator access is limited to the front of the computer, which includes the display and the touch screen.

IMPORTANT Access to components behind the panel where the computer is installed is restricted to authorized and properly trained personnel.

- When the computer is mounted in an enclosure, keep the enclosure door closed during operation so dust and other airborne contamination do not infiltrate the computer. Open the door only for routine maintenance.



SHOCK HAZARD: Do not operate the computer with the covers removed. An electrical shock hazard exists. All covers are required to maintain EMI shield.

- Always use the proper power down procedures as required by your operating system, such as the Shut Down command in the Microsoft Windows operating system.
- After you shut down the computer, do not apply power again until shutdown is complete.

Touch Screen Precautions



WARNING: If the LCD screen darkens or if the backlight is not functioning properly, the screen can be difficult to read and use of this screen could result in a potentially hazardous outcome. Do not use the LCD touch screen under these circumstances.

System design must take into account that the LCD screen or LCD touch screen can lose functionality and therefore be unable to maintain or change control of the system. The touch screen cannot be the single point of control of critical functions and is not intended to replace an E-stop.

System design must follow all applicable code and good engineering practice. Factors to consider include the following:

- The possibility of an unreadable LCD screen
- The possibility of an inoperable touch screen
- Unexpected communication errors or delays
- Operator error in the control of the system
- Proper use of E-stops and other safety practices

You must provide means to achieve a safe state during anomalies and help ensure the system has adequate redundancy for critical functions.

Failure to follow these instructions can result in death, serious injury, or equipment damage.

Start the Computer

Follow these steps to start the computer.

IMPORTANT The following steps apply to when you must manually start the computer. See [Connect Power on page 25](#) for when power is applied to the computer for the first time.

1. Make sure all necessary peripheral devices are connected to the corresponding I/O ports on the computer.
2. Make sure any connected components with separate power supplies (such as an external display) are turned on first.
3. See [Connect Power on page 25](#) for how to install DC power to the DC power input on the computer.
4. Apply 18...32V DC power to the computer.
5. Press the power switch on the computer.

See [Hardware Features on page 11](#) for the power switch location.

The computer performs certain actions every time it is started or reset. See [Restart the Computer](#) for what is done.

If your computer does not start or you notice other anomalies, refer to [Troubleshooting on page 68](#).

Restart the Computer

Use either of the following methods to restart the computer:

- From the Start menu, choose Restart.
- Press CTRL+ALT+DEL on an attached keyboard and click Restart.

During a restart, the computer does the following:

- Clears the RAM.
- Starts the POST.
- Initializes peripheral devices, such as drives and printers.
- Loads the operating system.

Use the computer display to view the progress of the POST, the initialization of accessory devices, and the start-up dialogs for the operating system that is installed.

Shut Down the Computer

Use either of the following methods to shut down the computer.

Method	Actions
Windows OS	With an attached keyboard and mouse, do one of the following. <ul style="list-style-type: none"> • Press CTRL+ALT+DEL and click Shut Down. • From the Start menu, click or choose Shut Down from the pull-down menu.
Power switch	Press the power switch to shut down the computer. See Hardware Features on page 11 for the power switch location. IMPORTANT: Access to components behind the panel where the computer is installed is restricted to authorized and properly trained personnel.

After shutting down the computer, do not apply power again until shutdown is complete.

Adjust the Display Brightness

Display computers have an adjustable display brightness setting that can be adjusted in the BIOS. The default setting is 70%.

Follow these steps to adjust the display brightness.

1. Restart the computer as detailed in [Restart the Computer on page 29](#).
2. During POST, press F2 to access the BIOS set-up utility.

TIP Use the arrow keys on a keyboard to navigate between BIOS menus and menu selections.

3. Use the BIOS set-up utility to adjust the display brightness.

IMPORTANT Brightness increased above the default setting reduces the life of the backlight, particularly at high temperatures.

Notes:

Replace Components

Topic	Page
Accessories and Replacement Parts	31
Voltage Precautions	31
Electrostatic Discharge Precautions	32
Pre-configuration	32
Post-configuration	33
Tools for Component Replacement	33
Remove the Cover	33
Reinstall the Cover	34
Replace a Solid-state Drive	35
Load a CompactFlash Card	36
Install an Add-in Card	37
Replace or Add Memory Modules	38

Accessories and Replacement Parts

You can view a current list of accessories and replacement parts at: <http://ab.rockwellautomation.com/Computers/Hazardous-Location-Display-Computers#selection>.

Review the specifications of a new component before you install it to verify that it is compatible with the computer. Record the model and serial number, and any other pertinent information of new components for future reference.

IMPORTANT We recommend that you use only Allen-Bradley® approved accessories and replacement parts.

Voltage Precautions

The computers contain line voltages. Disconnect all power to the computer before you install or remove components.



SHOCK HAZARD: Disconnect all power to the computer before you remove components.

Failure to disconnect power can result in severe electrical shock to an individual or electrostatic discharge (ESD) damage to the computer and components.

Electrostatic Discharge Precautions



ATTENTION: Electrostatic discharge (ESD) can damage static-sensitive devices or microcircuitry.

- Disconnect all power before you work on the computer as detailed in [Voltage Precautions on page 31](#).
 - Observe proper packaging and grounding techniques to help prevent damage.
-

Follow these precautions:

- Transport the computer and replacement parts in static-safe containers, such as conductive tubes, bags, or boxes.
- Keep electrostatic-sensitive parts in their containers until they arrive at the designated static-free work area.
- Cover the designated work area with approved static-dissipating material:
 - Use an anti-static wriststrap that is connected to the work surface.
 - Use properly grounded tools and equipment.
- Keep the designated work area free of nonconductive materials, such as ordinary plastic assembly-aids and foam packing.
- Avoid contact with pins, leads, or circuitry.
- Always hold components with a printed circuit board (PCB) by its edges and place it with the assembly side down.

Pre-configuration

IMPORTANT

When you install hardware or you perform maintenance procedures that require access to internal components, we recommend that you first back up all computer data to avoid loss.



ATTENTION: Make sure to read and understand all installation and removal procedures before you begin to configure the computer hardware.

Follow these steps before you remove the cover or replace a hardware component.

1. Shut down the computer and all peripherals that are connected to it.
2. Disconnect all cables from power outlets to avoid exposure to high energy levels.
If necessary, label each cable to expedite reassembly.
3. Disconnect telecommunication cables to avoid exposure to a shock hazard from ring voltages.

Post-configuration

Follow these steps after you install or remove a hardware component.

1. Make sure that all components are installed according to instructions.
2. Make sure that no tools or loose parts are left inside the computer.
3. Reinstall any expansion boards, peripherals, and system cables that were previously removed.
4. Reinstall the cover according to the instructions on [page 34](#).
5. Reconnect all external cables and power to the computer.
6. Press the power switch to start the computer.

Tools for Component Replacement

The following tools are required for component replacement:

- #2 cross-head screwdriver
- Anti-static wriststrap

Remove the Cover

To install, replace, or upgrade internal computer components, you must first remove the cover.

Follow these steps to remove the rear cover (the display computer is shown).

1. Follow the steps for [Pre-configuration on page 32](#).
2. Loosen the three screws that secure the rear cover (A).
3. Open the cover (B) and detach it from the chassis (C).

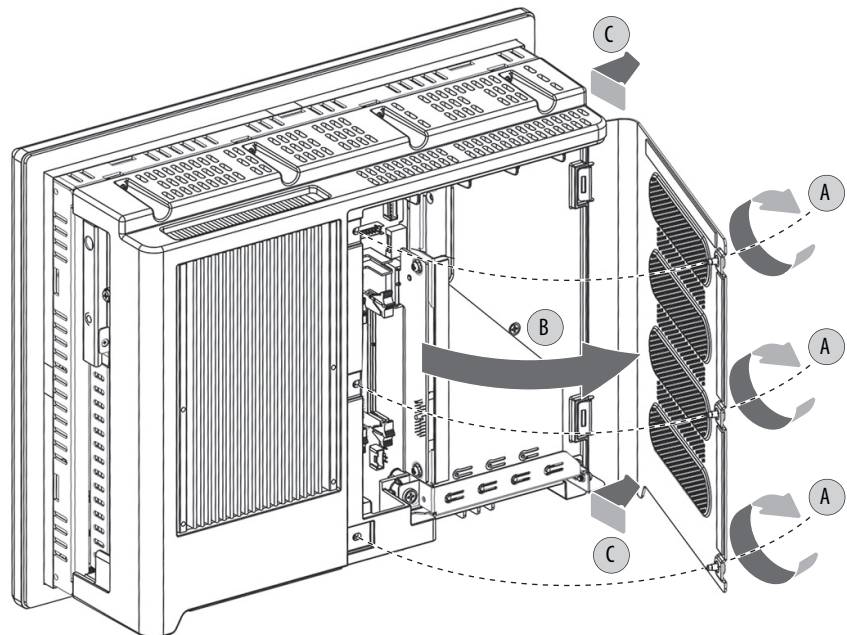

4. After you have installed, replaced, or upgraded internal computer components, reinstall the cover as detailed in [Reinstall the Cover on page 34](#).

Reinstall the Cover

Follow these steps to reinstall the rear cover (the display computer is shown).

1. Follow steps 1...3 for [Post-configuration on page 33](#).
2. Reattach the rear cover to the chassis (A).
3. Close the cover (B).
4. Tighten the three screws to secure the rear cover (C).

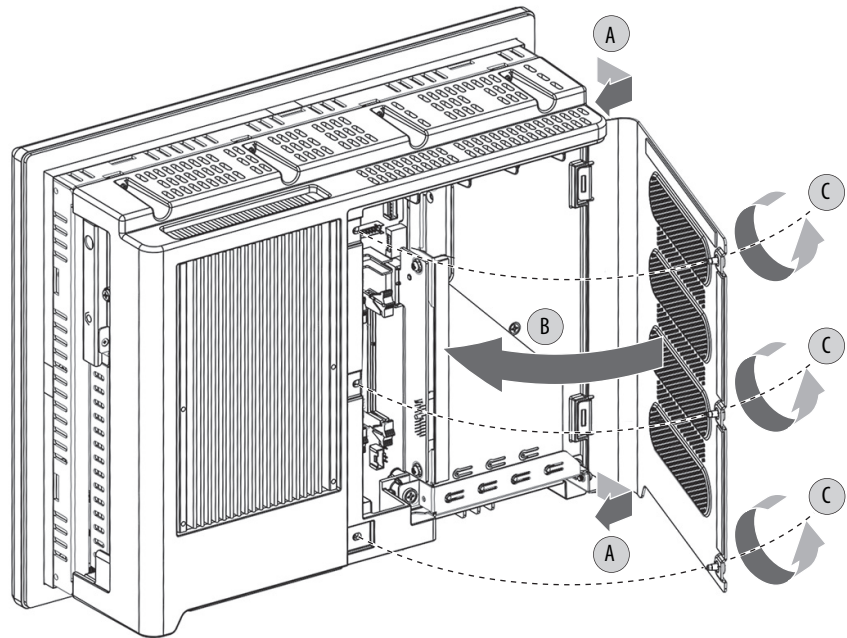

5. Follow steps 5 and 6 for [Post-configuration on page 33](#).

Replace a Solid-state Drive



WARNING: The solid-state drive (SSD) bay on the side of all computer models is not hot-swappable. You must first shut down the computer before you can insert or remove a SSD tray from this bay.

Do not connect or disconnect components unless power has been switched off and the area is known to be non-hazardous.

See [Hardware Features on page 11](#) for the SSD location.



WARNING: Use only catalog numbers 6189X-128GBSSD and 6189X-256GBSSD drive trays in the 6181X computers for hazardous locations. Substitution of components can impair suitability for hazardous locations.

Follow these steps to replace a SSD tray in the SSD bay on the side of the computer.

1. Follow the steps for [Pre-configuration on page 32](#).
2. Loosen the screw that secures the slot cover of the drive bay (A).
3. Loosen the screw that secures the drive bay lever (B).
4. Open the drive bay lever (C).
5. Pull out the existing SSD tray (D).
6. Push in the new SSD tray (E).
7. Close the drive bay lever (F).
8. Tighten the screw that secures the drive bay lever (G).
9. Tighten the screw that secures the slot cover of the drive bay (H).

IMPORTANT For computers in ATEX and IECEx applications, both screws for the drive bay (steps G and H in the illustration below) must be hand-tightened and verified as secure.

10. Follow the steps for [Post-configuration on page 33](#).

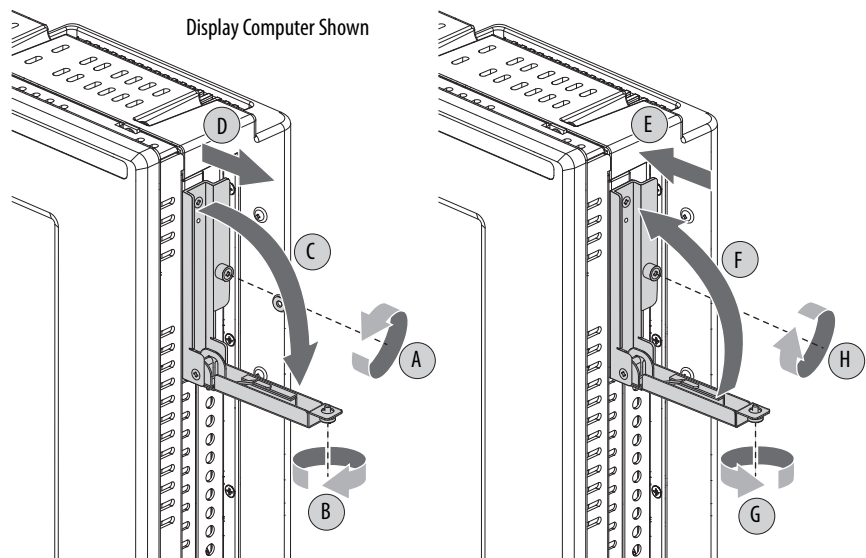

Load a CompactFlash Card

The computers have one location to load a CompactFlash (CF) Type II card, which is the slot on the I/O port panel below the serial ports. This slot is functionally hot-swappable but only in a non-hazardous location. It is meant to be a data slot but it is bootable.



WARNING: Do not connect or disconnect components unless power has been switched off and the area is known to be non-hazardous.

See [Hardware Features on page 11](#) for the CF card slot location.



WARNING: Use only catalog numbers 6189V-CFSSD8GB and 6189V-CFSSD16GB CF cards in the 6181X computers for hazardous locations. Substitution of components can impair suitability for hazardous locations.

Follow these steps to load a CF card in the bottom CF card slot.



WARNING: The CF card slot on the bottom side of all computer models is hot-swappable but only in a non-hazardous location. You can insert or remove a card from this slot while the computer is powered on. When the computer is used in a hazardous location, do not insert or remove a card in the bottom CF card slot unless power has been switched off.

1. Loosen the screw that secures the CF card slot cover (A).
2. Open the CF card slot cover (B).

If necessary, remove an inserted card by pushing the button on the hinge side.

3. Insert the new CF card into the slot until it is firmly seated (C).



ATTENTION: When properly seated, more than 80% of the CF card easily inserts into the slot before you encounter resistance. If you encounter resistance sooner, then remove the card, rotate it 180°, and reinsert.

Do not force the card into the slot or you can damage the connector pins.

4. Close the CF card slot cover (D).
5. Tighten the CF card slot cover screw (E).

IMPORTANT

For computers in ATEX and IECEx applications, the CF card slot cover screw (step E in the illustration below) must be hand-tightened and verified as secure.

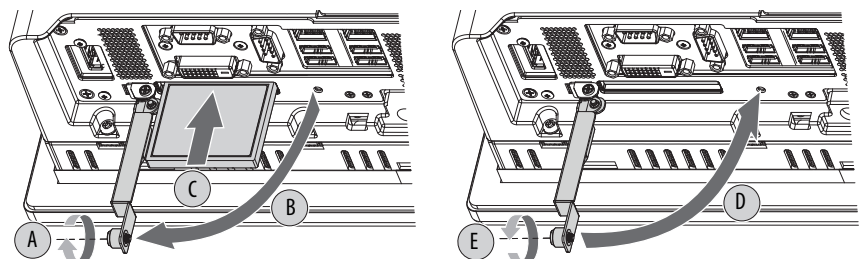

Install an Add-in Card

IMPORTANT When used in hazardous locations, the computer supports peripheral cards rated 4 W maximum, and the add-in card must be certified to UL Class I, Division 2 Groups A, B, C, D, T4, or ATEX/IECEx Zone 2 as applicable to the area of installation. For ATEX and IECEx applications, operation in Group IIC Category 3 gas and dust environments is supported.

At maximum computer temperature, consider the following:

- A PCI card that dissipates 4 W can experience a surrounding air temperature up to 90 °C (194 °F). A T4 max temperature code is required.
- A PCI card that dissipates 1 W can experience a surrounding air temperature up to 85 °C (185 °F). A T4 max temperature code is required.

Follow these steps to install an add-in card.

1. Disconnect power from the computer.
2. Remove the back cover from the computer.
See [Remove the Cover](#) instructions on [page 33](#) for more information.
3. Remove the one screw that secures the slot cover.
Do not discard the screw.
4. Remove the slot cover and store it for reassembly later.



ATTENTION: Do not discard the slot cover. If the add-in card is removed in the future, the slot cover must be reinstalled to maintain agency access requirements.

5. Hold the add-in card by its edge and remove it from its protective packaging.
6. Connect the add-in card to the compatible riser-board slot.
Verify that the card is properly seated in the slot.
7. Secure the add-in card with the screw from the slot cover.
8. Connect the necessary cables to the add-in card.
See the documentation that came with the card.
9. Reinstall the computer cover as detailed in [Reinstall the Cover on page 34](#).

Replace or Add Memory Modules

The computers have two dual-channel DDR3 SO-DIMM slots that support up to 16 GB maximum system memory.

Figure 5 - Memory Module Slots and Module Alignment

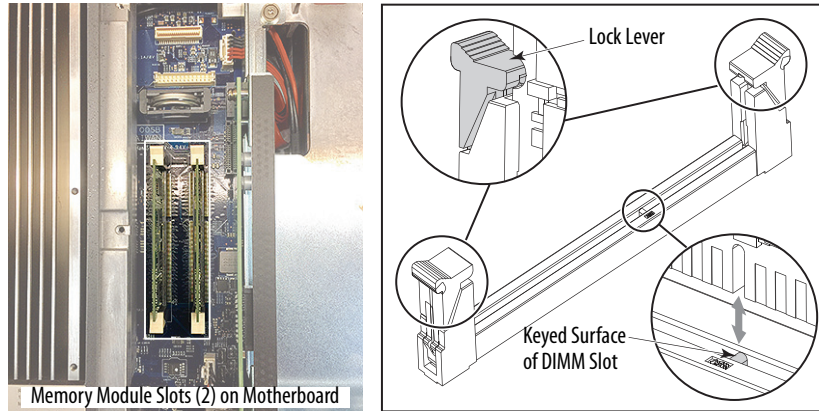

IMPORTANT Computer performance is optimized when both slots are populated with memory modules of the same capacity.
All 6181X computers ship with a dual memory module configuration.

Memory Configuration Guidelines

Follow these guidelines when you replace or add memory to the computers.



WARNING: Unless ordered differently, 6181X computers ship with 8 GB of memory (2 x 4 GB). If upgrading to 16 GB of memory (2 x 8 GB), use only catalog number 6189X-16GDDR3, which is memory specifically for use in hazardous locations. Other memory modules are not acceptable for use in hazardous locations.

To avoid system instability, use the same brand and model number of memory in the two slots.

See <http://ab.rockwellautomation.com/Computers> for qualified replacement parts and accessories.

Replace or Add a Memory Module

Follow these steps to replace or add a memory module.

IMPORTANT Use an anti-static wriststrap connected to the work surface, and properly grounded tools and equipment.

1. Follow the steps for [Pre-configuration on page 32](#).
2. Remove the computer cover as detailed in [Remove the Cover on page 33](#).
3. Locate the memory module that you want to replace. See [Figure 5 on page 38](#) for memory location on the motherboard.
4. Remove the selected memory module.
 - a. Use your thumbs or two fingers to push open the lock levers, which release the memory module from its slot for easy removal. See [Figure 5 on page 38](#).
 - b. Gently pull out the memory module to remove it from its slot.
 - c. Place the memory module on a static-dissipating work surface or inside an antistatic bag.
5. Install the new memory module.
 - a. Hold the memory module by its edges as you remove it from its antistatic bag.
 - b. Orient the module so the notch on its bottom edge aligns with the keyed surface of the DIMM slot. See [Figure 5 on page 38](#).

TIP The keyed surface is off center to assist the correct alignment.
 - c. Press the module fully into the slot to engage the lock levers. See [Figure 5 on page 38](#).
6. Reinstall the computer cover as detailed in [Reinstall the Cover on page 34](#).
7. Follow the steps for [Post-configuration on page 33](#).

Real-time Clock (RTC) Battery

This computer contains a lithium battery that you cannot replace. Return the computer to Rockwell Automation for battery replacement.

For return information, contact your local distributor or Rockwell Automation representative, or visit <http://www.rockwellautomation.com/services/online-phone>.



The sealed lithium battery contained in this computer could need replacement during the life of the computer.

At the end of its life, collect the battery in this computer separately from any unsorted municipal waste.

Notes:

Set Up the UEFI Utility

Topic	Page
Set-up Utility Overview	41
Access the Set-up Utility	42
Set-up Screen Overview	42
Firmware Update	43
Firmware Configuration	44
Diagnostics	54
AMI Rescue	55
Hardware History	64
Exit	65

Set-up Utility Overview

The set-up utility is a hardware configuration program built into the universal extensible firmware interface (UEFI). In this chapter, UEFI replaces Basic Input/Output System (BIOS) to describe the system firmware except where BIOS is specifically used, such as on a graphical interface.

The UEFI is already configured and optimized so there is no need to run this utility. However, you can run the set-up utility to do the following:

- Change the system configuration.
- Change the UEFI setup when a configuration error is detected by the system.
- Redefine communication ports to prevent any conflicts.
- Read the current amount of system memory.
- Change the boot drive order.
- Set or change the password or make other changes to the security settings.
- Upgrade the system firmware.
- Run the diagnostic utility to determine the cause of system malfunction.
- Restore or back up the operating system.

Access the Set-up Utility

Follow these steps to access the set-up utility in your computer.

1. Start your computer.
2. During POST, you have two selections to access the set-up utility.

Press	Result
F2	Accesses a graphical interface of set-up environment. IMPORTANT: Screen shots in this chapter are from the UEFI graphical interface.
DEL (delete)	Accesses a text mode set-up environment.

Set-up Screen Overview

The set-up screen is the main screen for the UEFI graphical interface. On the left are six menu buttons that are stacked vertically. Each menu button provides access to information, commands, or configurable options for the following topics:

- [Firmware Update](#)
- [Firmware Configuration](#)
- [Diagnostics](#)
- [AMI Rescue](#)
- [Hardware History](#)
- [Exit](#)

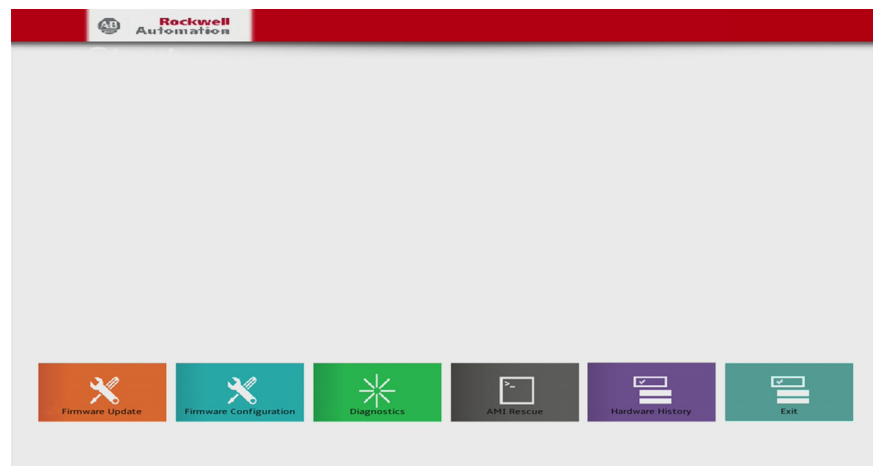

TIP The UEFI graphical interface can be driven with either the integrated touchscreen or a keyboard and mouse.

Firmware Update

You can update your system firmware from the Firmware Update menu.



Enter File Name

Browser

Flash

Parameter	Description
Browse	Click to navigate to the firmware file saved onto a media.
Firmware file location	Select or type the file name for the firmware file.
Flash	Click to start the BIOS programming.

Follow these steps to update the system firmware.

1. Click Firmware Update on the set-up screen.

The Firmware Update screen appears.

2. Click Browse to locate the firmware file.

IMPORTANT

The USB mass storage device that contains the firmware file must be FAT, FAT16, or FAT32 formatted to be recognized.

See <http://www.rockwellautomation.com/compatibility/> to check for revisions and to download firmware files.

3. Click Flash.

Firmware Configuration

You can view and modify the various system parameters from the Firmware Configuration menu. On the left are six menu options that are stacked vertically.



Menu	Description
Main	Use this menu to view general computer information and for basic system configuration.
Advanced	Use this menu to configure information for the PXE, PCI, ACPI, processor, SATA, USB, power, video graphics, super IO, hardware monitor, and AMT.
Chipset	Use this menu to configure system chipset information.
Security	Use this menu to set or change user and administrator passwords.
Boot	Use this menu to configure boot device priority.
Save & Exit	Saves changes and reset, discards changes and reset, or restore defaults.

Main

Rockwell Automation

← Setup

- Main
- Advanced
- Chipset
- Boot
- Security
- Save & Exit

BIOS Information

BIOS Vendor American Megatrends

Compliance UEFI 2.4

BIOS Version R00T04D

Build Date and Time 11/08/2016 15:35:43

Total Memory 8192 MB (DDR3)
Total Memory in the System.

Memory Frequency 1600 Mhz
Displays the Frequency of Memory

System Date 11/11/2016
Set the Date. Use Tab to switch between Date elements.

System Time 10:55:22
Set the Time. Use Tab to switch between Time elements.

Runtime hours 41

Manufacturer Rockwell Automation/

Parameter	Description
BIOS Vendor	BIOS manufacturer
BIOS Version	BIOS version information
Build Date and Time	Date and time BIOS was created.
Total Memory	Total system memory and memory type (in parentheses)
Memory Frequency	Frequency of installed memory
System Date	Set the system date. Format: Weekday MM:DD:YYYY (Weekday Month:Day:Year)
System Time	Set the system time. Format: HH:MM:SS (Hour:Minute:Second)
Runtime Hours	Records the total hours of computer runtime.
Manufacturer	System manufacturer
Catalog Number	Allen-Bradley® catalog number with series letter
WIN Number	Warranty information number
Version-SYS	System version, manufacture date
Version-Board	System board version information
Serial Number	Unique system serial number
← Setup	Returns you to the main set-up screen; see page 42 .

Advanced

Enable PXE Boot

When PXE boot is enabled, a computer boots from a server on a network before it boots the operating system on the local storage drive.

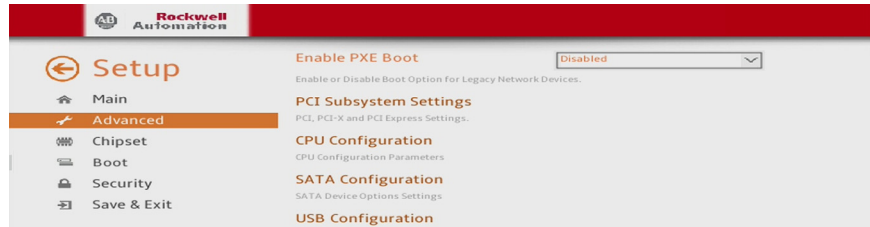

Parameter	Description
Enable PXE Boot	Enables or disables boot option for legacy network devices. Options: Enabled or Disabled (default)
⏪ Setup	Returns you to Firmware Configuration set-up screen; see page 46 .

PCI Subsystem Settings

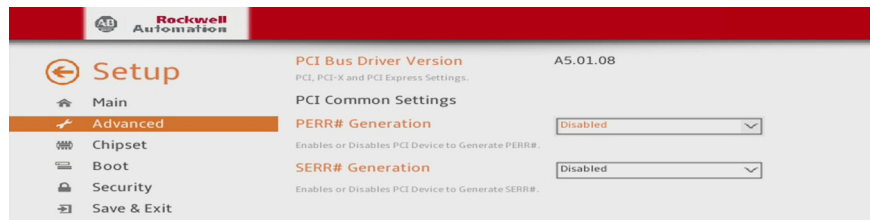

Parameter	Description
PCI Bus Driver Version	Displays the PCI bus driver version information.
PERR# Generation	Enables or disables PCI Device to Generate PERR#. Options: Enabled or Disabled (default)
SERR# Generation	Enables or disables PCI Device to Generate SERR#. Options: Enabled or Disabled (default)
⏪ Setup	Returns you to the main set-up screen; see page 42 .

CPU Configuration

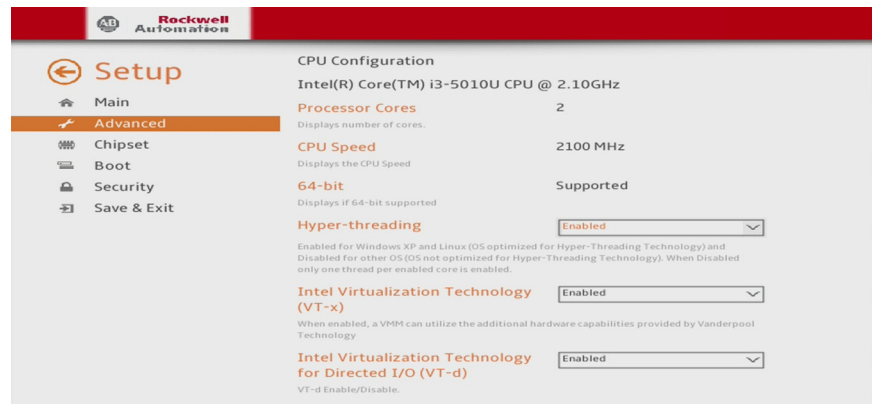

Parameter	Description
CPU Configuration	Displays processor type and maximum speed.
Processor Cores	Displays processor core count.
CPU Speed	Displays maximum speed of the processor.
64-bit	Displays 64-bit support status.
Hyper-threading	Enables or disables the hyper-threading technology. Options: Enabled (default) or Disabled
Intel Virtualization Technology (VT-x)	When enabled, a Virtual Memory Manager (VMM) can use the extra hardware capabilities provided by Vanderpool Technology. Options: Enabled (default) or Disabled
Intel Virtualization Technology for Directed I/O (VT-d)	Enables or disables VT-d. Options: Enabled (default) or Disabled
⏪ Setup	Returns you to Firmware Configuration set-up screen; see page 46 .

SATA Configuration (AHCI and RAID modes)

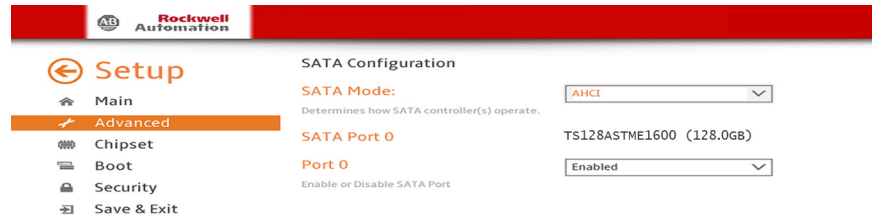

Parameter	Description
SATA Mode Selection	Select an operation mode for the onboard SATA controller. Options: AHCI (default) or RAID
SATA Port (0, 1)	Indicates the SATA drive connected to the SATA connector.
Port (0, 1)	Enables or disables the SATA drive connected to the SATA port. Options: Enabled (default) or Disabled
Setup	Returns you to Firmware Configuration set-up screen; see page 46 .

USB Configuration

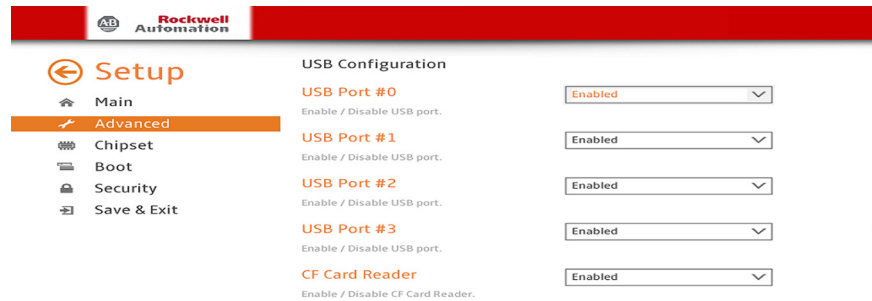

Parameter	Description
USB Ports	Enables or disables a USB port. Options: Enabled (default) or Disabled Ports #0...#3: Bottom of computer (see page 11 for port locations) CF Card Reader: (internal; see page 36 for CF card location) IMPORTANT: If you disable a USB port, it reduces access risk from unauthorized or malicious sources.
Setup	Returns you to Firmware Configuration set-up screen; see page 46 .

Power Configuration

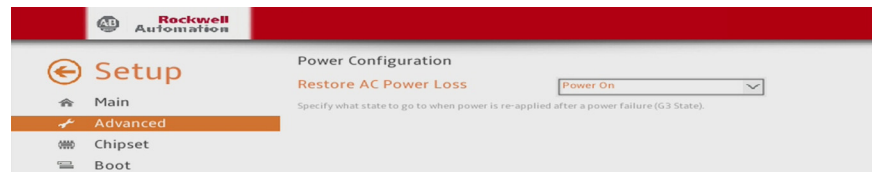

Parameter	Description
Restore AC Power Loss	Specify what state to go to when power is reconnected after a power failure (G3 state). Options: Power off, Power on (default), Last State
Setup	Returns you to Firmware Configuration set-up screen; see page 46 .

Super I/O Configuration

Parameter	Description
Super I/O Chip	Displays the Super I/O chipset information.
Serial Port 1 Configuration	Select to set parameters for serial port 1.
Serial Port 2 Configuration	Select to set parameters for serial port 2.
Setup	Returns you to Firmware Configuration set-up screen; see page 46 .

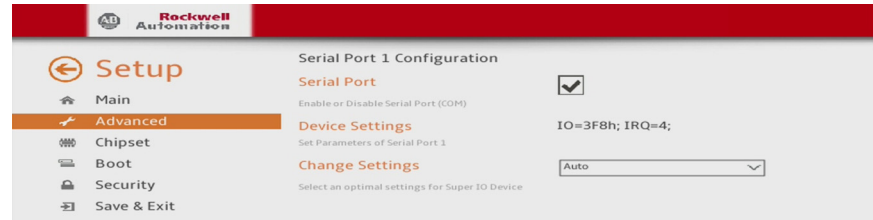
Table 3 - Serial Port 1 Configuration

Parameter	Description
Serial Port	Enables or disables the serial (COM1) port. Options: Checked box (enabled; default) or unchecked box (disabled)
Device Settings	Displays the Base I/O address and IRQ setting of serial port 1.
Change Settings	Select an optimal setting for the super I/O device. Options: Auto (default), IO=3F8h; IRQ=4, IO=2F8h; IRQ=4, IO=3E8h; IRQ=4, IO=2E8h; IRQ=4

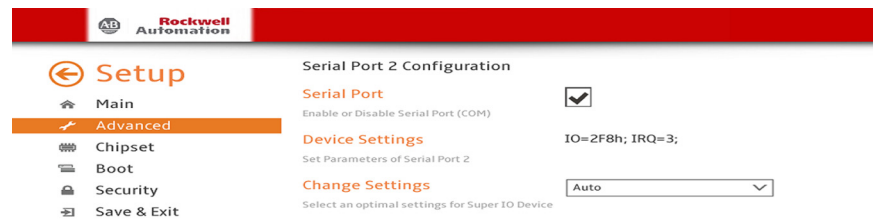
Table 4 - Serial Port 2 Configuration

Parameter	Description
Serial Port	Enables or disables the serial (COM2) port. Options: Enabled (default) or Disabled
Device Settings	Displays the Base I/O address and IRQ setting of serial port 2.
Change Settings	Select an optimal setting for the super I/O device. Options: Auto (default), IO=2F8h; IRQ=3, IO=3F8h; IRQ=3, IO=3E8h; IRQ=3, IO=2E8h; IRQ=3

Hardware Monitor

Rockwell Automation

Setup

- Main
- Advanced**
- Chipset
- Boot
- Security
- Save & Exit

Pc Health Status

- CPU Temperature : +27
- DIMM1 Temperature : +25
- DIMM2 Temperature : +25
- Vcore Temperature : +31
- MB Temperature : +26
- VCORE_S0_CPU : +1.568 V
- V1D05_S0 : +1.040 V
- V1D5_S0 : +1.488 V
- V12D0_S0 : +11.904 V
- VDDQ_S3_MEM : +1.328 V
- V3D3_S0 : +3.328 V
- V5D0_S0 : +4.993 V

Rockwell Automation

Setup

- Main
- Advanced**
- Chipset
- Boot
- Security
- Save & Exit

- V3D3_S0 : +3.328 V
- V5D0_S0 : +4.993 V
- VBAT : +3.216 V
- CPU (U6502) Max : +45 degC 2016/10/24 07:27
- CPU (U6502) Min : +23 degC 2016/01/01 00:00
- DIMM1 (U6503) Max : +41 degC 2016/10/24 07:15
- DIMM1 (U6503) Min : +24 degC 2016/10/24 23:27
- DIMM2 (U6504) Max : +39 degC 2016/10/20 00:56
- DIMM2 (U6504) Min : +23 degC 2016/01/01 00:00
- Vcore (U6507) Max : +49 degC 2016/10/24 08:23
- Vcore (U6507) Min : +23 degC 2016/01/01 00:00
- MB (U6506) Max : +42 degC 2016/10/24 08:15
- MB (U6506) Min : +23 degC 2016/01/01 00:00

Parameter	Description
CPU temperature	Displays the current temperatures (in °C) and core voltages of various hardware components. All values are read-only.
DIMM1 temperature	
DIMM2 temperature	
Vcore Temperature	
MB Temperature	
VCORE_S0_CPU	
V1D05_S0	
V1D5_S0	
V12D0_S0	
VDDQ_S3_MEM	
V3D3_S0	
V5D0_S0	
VBAT	
CPU (U6502) Max	
CPU (U6502) Min	
DIMM1 (U6503) Max	
DIMM1 (U6503) Min	
DIMM2 (U6504) Max	
DIMM2 (U6504) Min	
Vcore (U6507) Max	
Vcore (U6507) Min	
MB (U6506) Max	
MB (U6506) Min	
Setup	Returns you to Firmware Configuration set-up screen; see page 46 .

Chipset

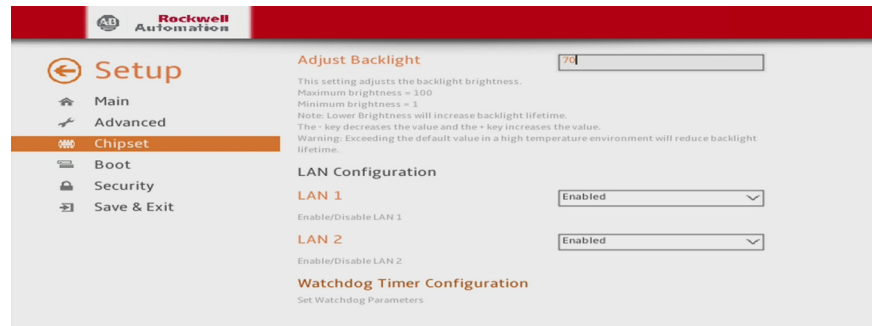

Parameter	Description
Adjust Backlight	Adjust the internal LCD LED backlight brightness. Number range: 1 to 100 with 100 as full (100%) brightness; 70 is default. IMPORTANT: Increasing the brightness from the default setting reduces the life of the LED backlight, particularly at high temperatures.
LAN 1	Enables or disables onboard LAN1 controller. Options: Enabled (default) or Disabled
LAN 2	Enables or disables onboard LAN2 controller. Options: Enabled (default) or Disabled
⏪ Setup	Returns you to the main set-up screen; see page 42 .

Watchdog Timer Configuration

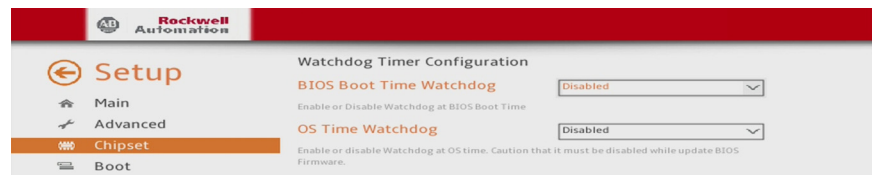

Parameter	Description
BIOS Boot Time WatchDog	Enables or disables BIOS boot timeout. Options: Enabled or Disabled (default)
BIOS Timer Out value ⁽¹⁾	Set BIOS timer timeout value (10, 20, or 30 minutes). 10 is default.
OS Time WatchDog	Enables or disables OS timeout. Options: Enabled or Disabled (default)
Timer Out (1-60 Min) ⁽²⁾	Set WatchDog timer timeout value (1...60 minutes) in 1 minute increments. 60 is default.
⏪ Setup	Returns you to the main set-up screen; see page 42 .

(1) This field is only visible when BIOS Boot time Watchdog is enabled.

(2) This field is only visible when OS time Watchdog is enabled.

IMPORTANT If you enable the BIOS Boot time Watchdog, then it must be disabled before you update the UEFI firmware.

Boot

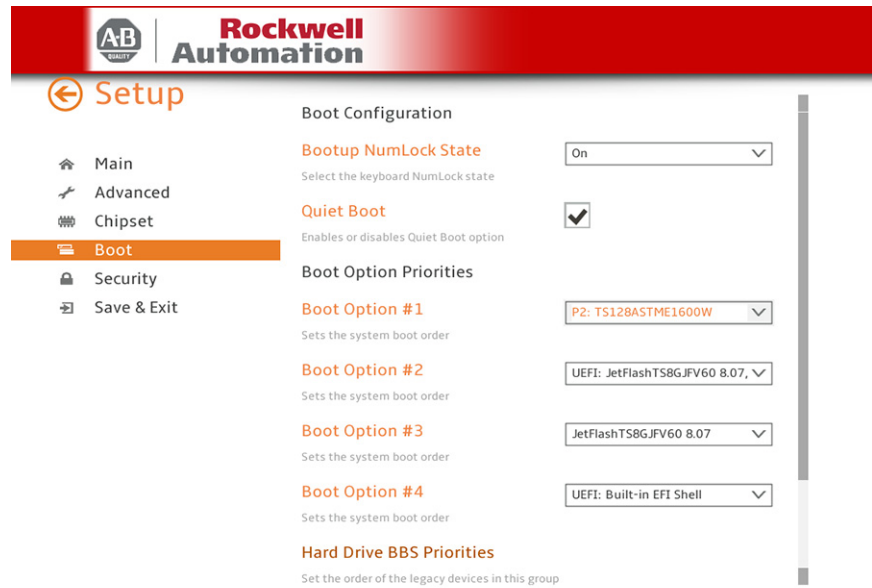

Parameter	Description
Bootup NumLock State	Enables or disables the Num Lock key on boot. Option: On (default) or Off
Quiet Boot	Enables or disables Quiet Boot option. Option: Enabled or Disabled (default) IMPORTANT: When enabled, this option hides the POST screen messages at computer startup.
Boot Option Priorities	Change the boot order. By default, these devices are the boot priority: <ul style="list-style-type: none"> • SSD • USB bootable device • PXE • UEFI shell Follow instructions in the dialog box to change the boot order, and to enable or disable options.
⏪ Setup	Returns you to the main set-up screen; see page 42 .

Security

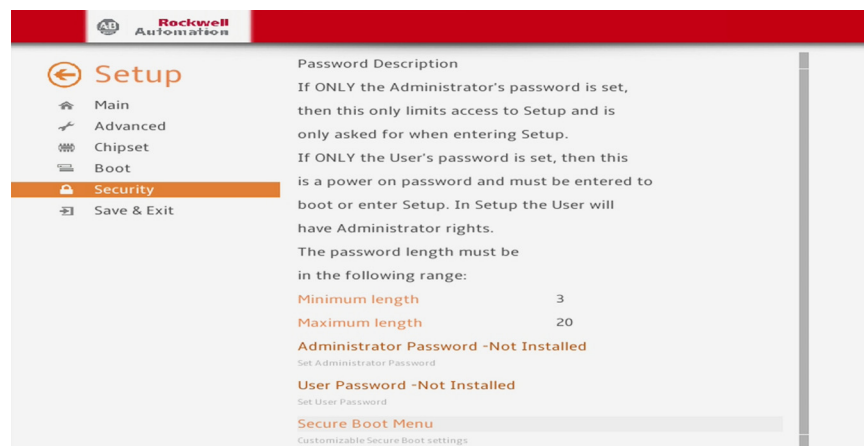

Parameter	Description
Administrator Password	Sets the administrator password. Use this password to reduce assess risk from unauthorized or malicious sources. IMPORTANT: If you forget the administrator password, there are two ways to reset it: <ul style="list-style-type: none"> • Remove and replace the battery; see RTC Battery on page 76. • Clear the UEFI; see Clear the CMOS on page 70.
User Password	Sets the user password. Use this password to reduce assess risk from unauthorized or malicious sources. IMPORTANT: If you forget the user password, there are two ways to reset it: <ul style="list-style-type: none"> • Remove and replace the battery; see RTC Battery on page 76. • Clear the UEFI; see Clear the CMOS on page 70.
Secure Boot Menu	Customizable secure boot settings. Disabled is the default setting.
← Setup	Returns you to the main set-up screen; see page 42 .

Save and Exit

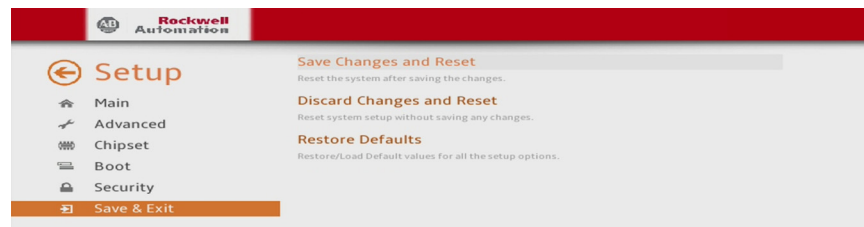

Parameter	Description
Save Changes and Reset	Saves changes that are made and closes the set-up utility.
Discard Changes and Reset	Discards changes that are made and closes the set-up utility.
Restore Defaults	Loads the optimal defaults in the set-up menu.
Save and Exit	Saves changes and exits the UEFI set-up utility.
← Setup	Returns you to the main set-up screen; see page 42 .

Diagnostics

The Diagnostics menu lets you run the diagnostics utility to determine the cause of the system malfunction by testing computer components, such as the processor, memory, drives, video, and other hardware.

Select a menu option by pressing the up ↑ or down ↓ arrow keys and pressing Enter when a menu is highlighted. Press the left ← or right → arrow keys to toggle between the five Diagnostics menu selections.

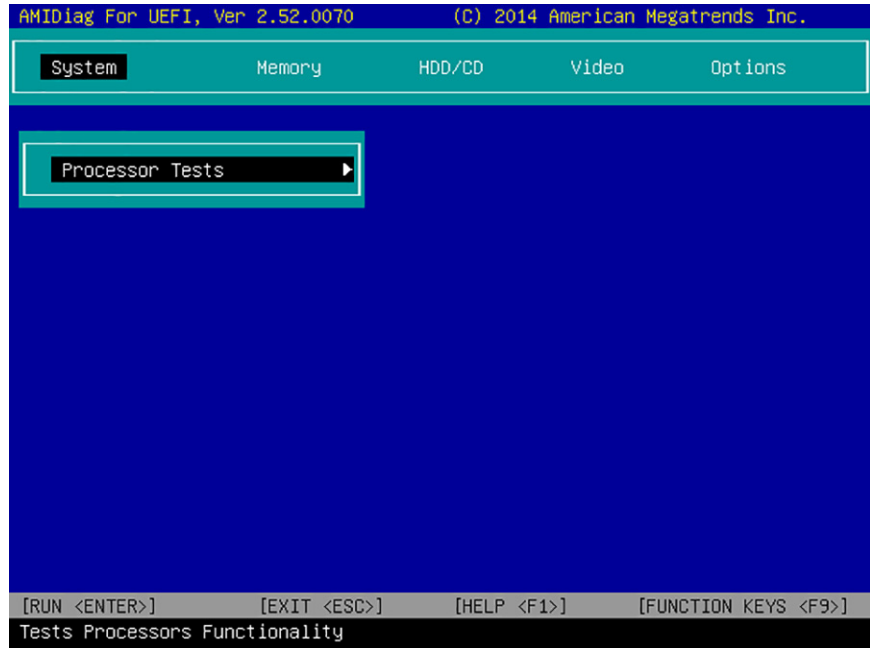

The following table lists the shortcut options in the Diagnostics menu.

Button	Description
Esc	Stops a test in progress or exits Diagnostics from any of the six menu options.
Enter	Runs the highlighted test or option.
F1	Displays the Help screens.
F2	Edits batch parameters.
F3	Loads batch parameters.
F4	Saves batch parameters.
F5	Selects or deselects the current test.
F6	Selects or deselects all tests in menu.
F7	Selects or deselects all tests.
F8	Selects or deselects all quick tests.
F9	Displays a list of the Diagnostic function keys.
F10	Runs the selected test or tests.

AMI Rescue

The AMI Rescue menu lets you back up the system image on your computer and restore that image.



IMPORTANT The following instructions are for the built-in backup and restore utility, AMI Rescue. You can also use third party utility or software to create an image backup and restore.

System images are also available from the Rockwell Automation® Product Compatibility and Download Center:

<http://compatibility.rockwellautomation.com/Pages/home.aspx>.

The Backup function does the following:

- Overwrites any data stored in a hidden partition.
- Saves any data as a new image file stored in a hidden partition.
- Saves any data on a mass storage device.

The Restore function overwrites any data on the primary operating system partition on the internal drive.

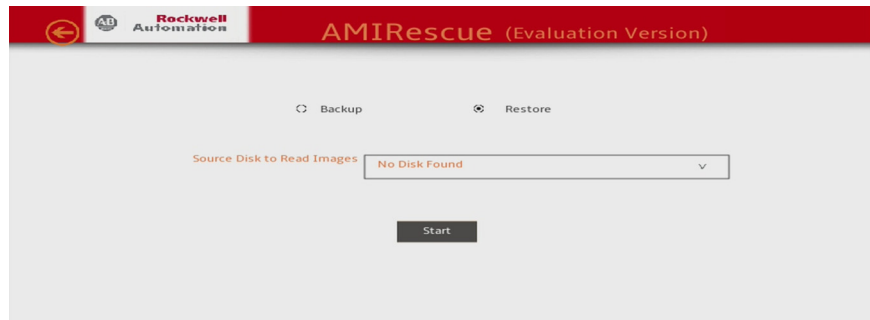

Parameter	Description
Restore	Click to access the restore features.
Source Disk to Read	Click to choose a source disk with images for the restore.
Start	Click to start the restore to disk.

Make a Backup

Follow these steps to back up the system image.

IMPORTANT Attach a FAT32-formatted USB storage device to the computer before you perform these steps. Use a USB storage device appropriately sized for the amount of data being backed up.

1. Click the AMI Rescue menu to access the AMI Rescue screen.
2. Click Make a Backup.
3. In the Source to Backup From field, click Browse to locate the backup source. The backup is automatically assigned a name based on the system date.

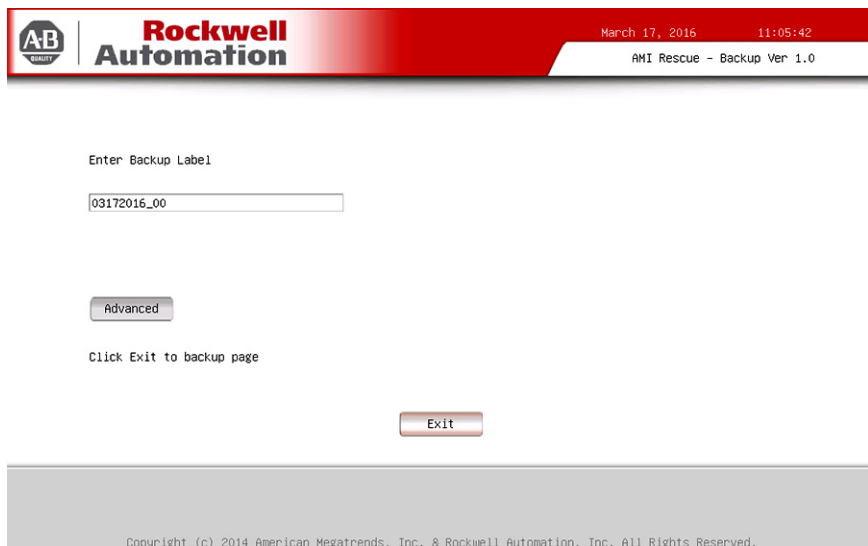

4. Click Advanced to select the partitions to back up.
5. Select all Disk 1 options so the entire OS image is backed up.

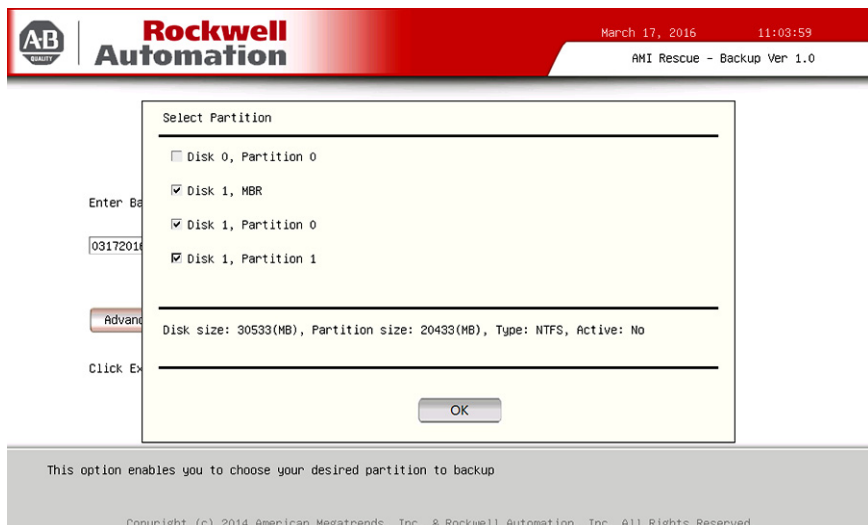

IMPORTANT Do not select Disk 0; it is meant for the USB mass storage device.

6. Click OK.
7. Click Exit.
8. In the Destination of Image File field, click Browse to locate the destination source.
9. From the List of Volumes menu, select the external USB drive.

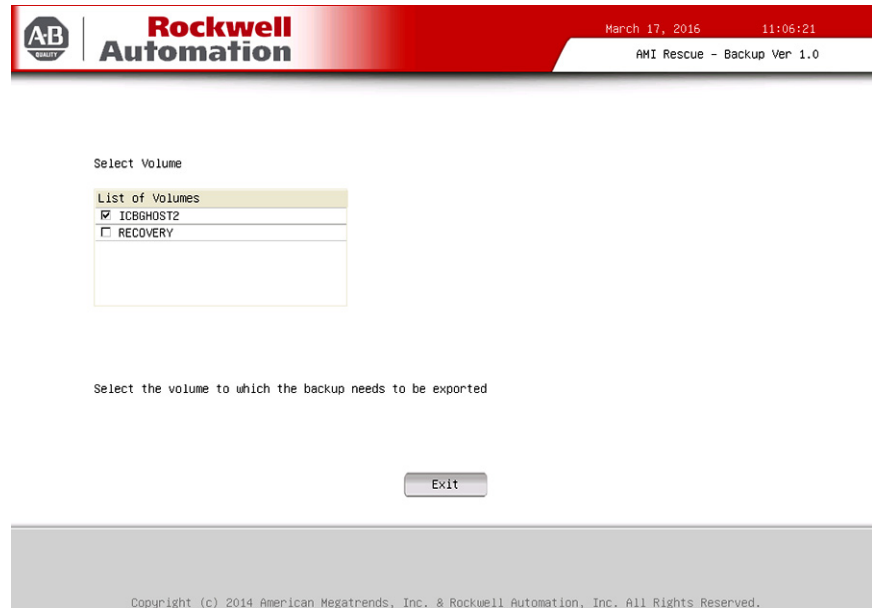

IMPORTANT Do not select Recovery; it is the factory OS image that you wish to back up.

10. Click Exit.
11. Click Backup Now.

Restore OS Image From a Hidden Partition

Perform the following steps to restore your computer to factory default settings.

IMPORTANT When you restore from a back-up image, all data on the target drive is replaced. Make sure all data is backed up before you proceed with the following steps.

1. Click the AMI Rescue menu to access the AMI Restore screen.
2. Click Restore from an Image.

3. In the Source of Image File field, click Browse to locate the image source.

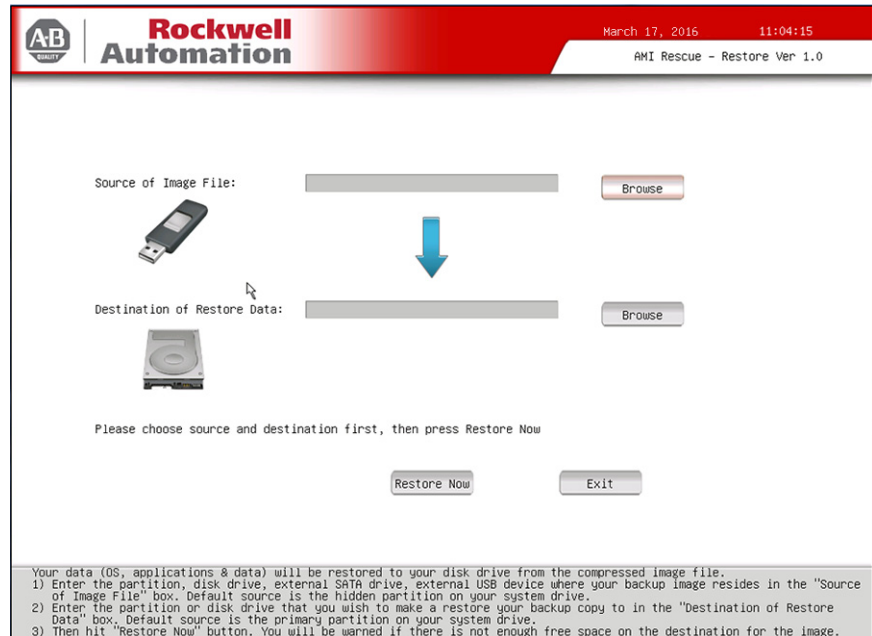

4. From the List of Volumes menu, select Recovery.

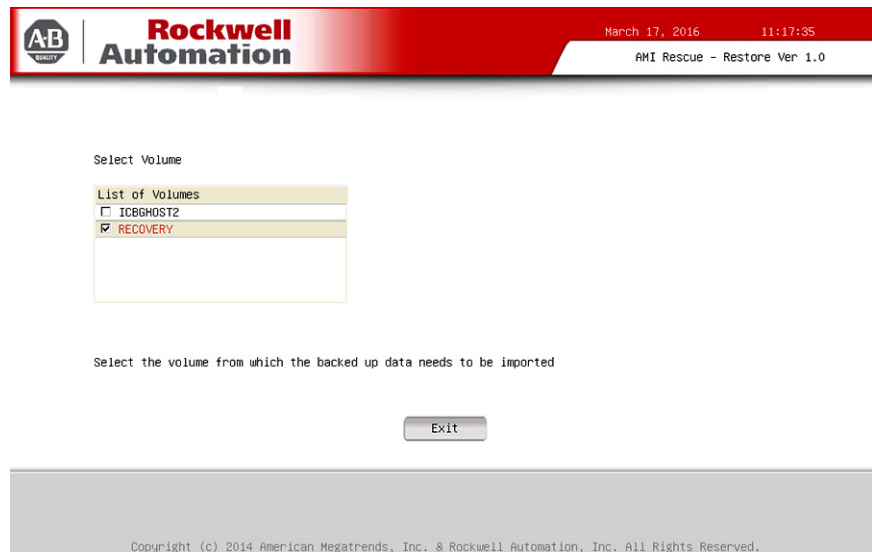

IMPORTANT Recovery is the default OS image source, which is the hidden partition on your internal storage drive.

5. Click Exit.

6. In the Destination of Restore Data field, click Browse to locate the destination source.

- From the List of Labels menu, select the default destination.

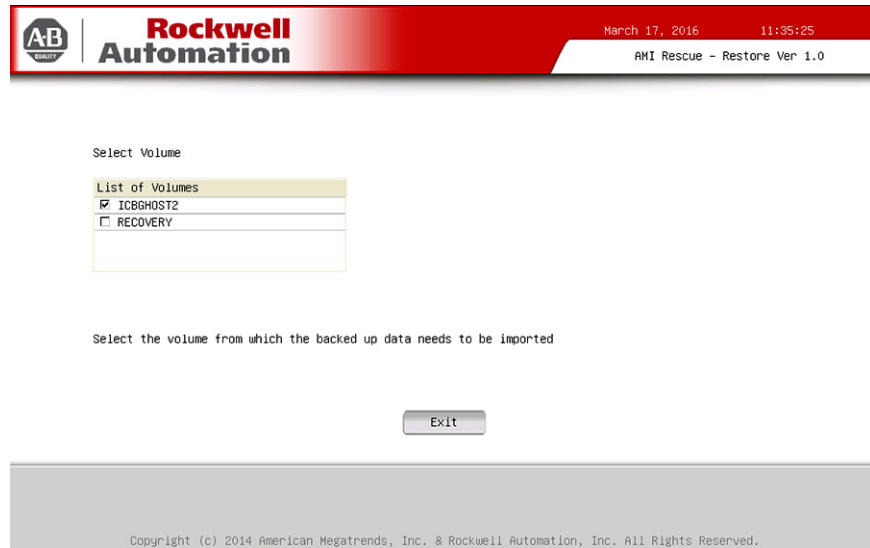

IMPORTANT The Label name is similar or identical to the above example.

- Click Advanced.
- On the Select Partition screen, select all boxes for Disk 0 so the entire OS image is restored.

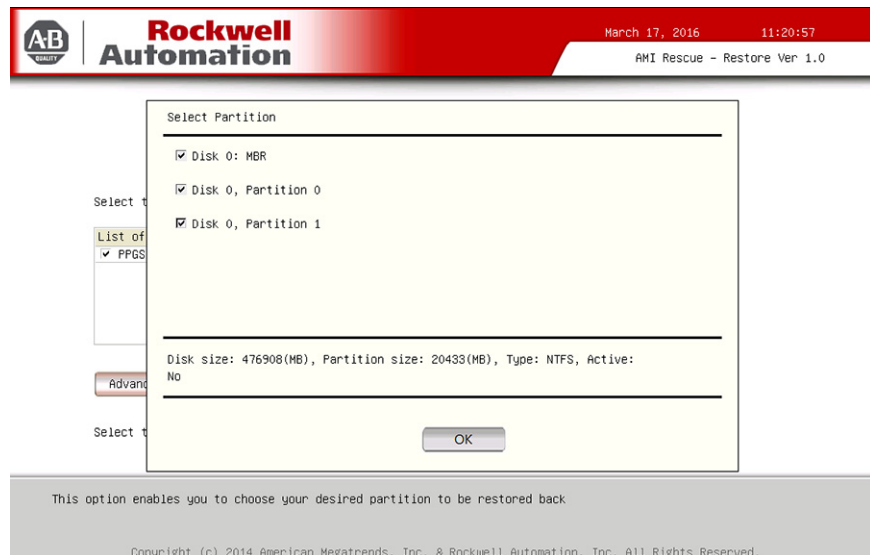

- Click OK.
- Click Exit.

12. Click Restore Now to start the restoration process.

IMPORTANT The following warnings may appear:

The restored destination may not have enough space due to the compression rate of backup image. Continue?

Yes No

If prompted, click Yes to continue.

Target partitions will be overwritten. Continue?

Yes No

If prompted, click Yes to continue.

Do you want to keep the current partition table?

Yes No

If prompted, click No to continue.

The current partition table will be restored to previous state. Continue?

Yes No

If prompted, click Yes to continue.

Restore OS Image From a USB Storage Drive

Perform the following steps to restore your computer with a backed-up OS image on an external USB storage drive.

IMPORTANT To perform these steps, you must already have a backed-up OS image on an external USB storage drive from [Make a Backup on page 56](#). Connect the USB storage drive to the computer before you perform these steps.

1. Click the AMI Rescue menu to access the AMI Restore screen.
2. Click Restore from an Image.

3. In the Source of Image File field, click Browse to locate the image source.

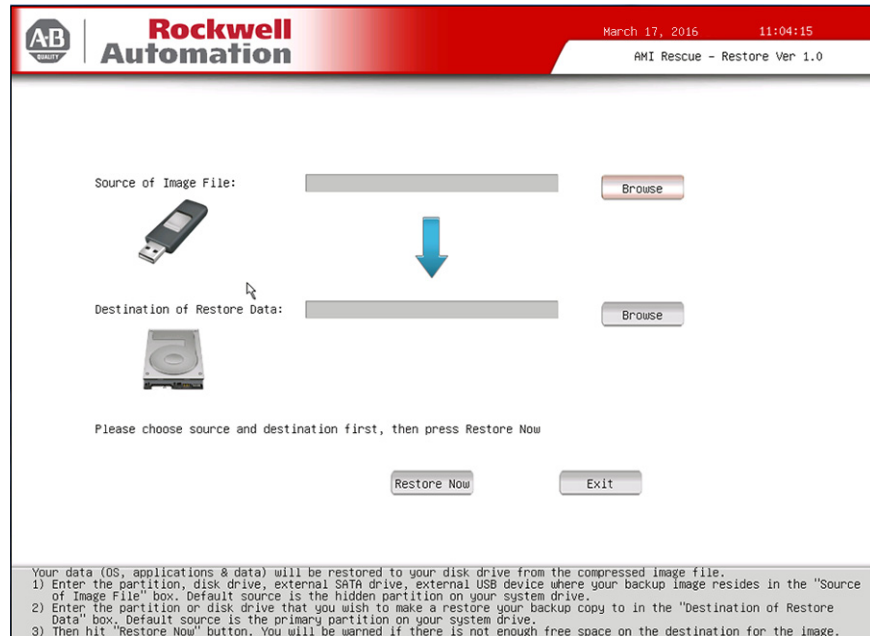

4. From the List of Volumes menu, select the USB storage drive.

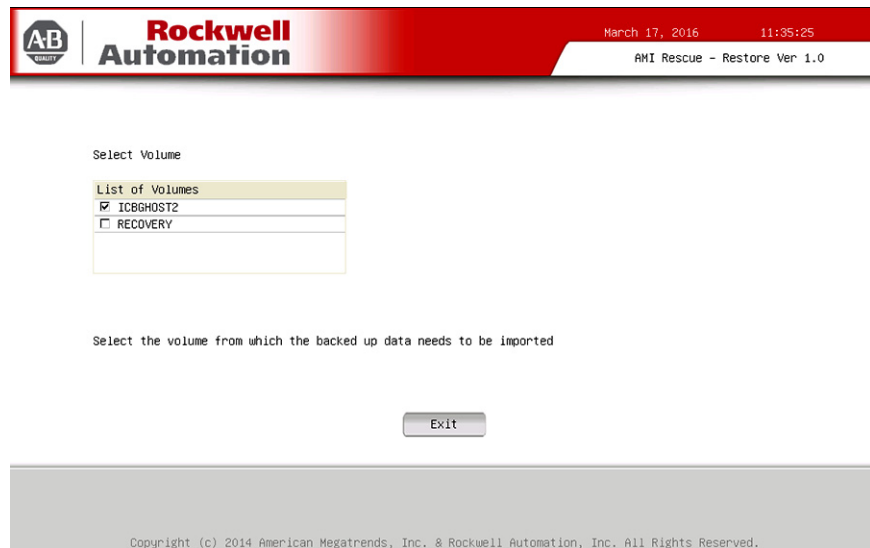

IMPORTANT Do not select Recovery; it is the OS image on the computer that you wish to restore.

5. Click Exit.
6. In the Destination of Restore Data field, click Browse to locate the destination source.

- From the List of Labels menu, select the USB storage drive.

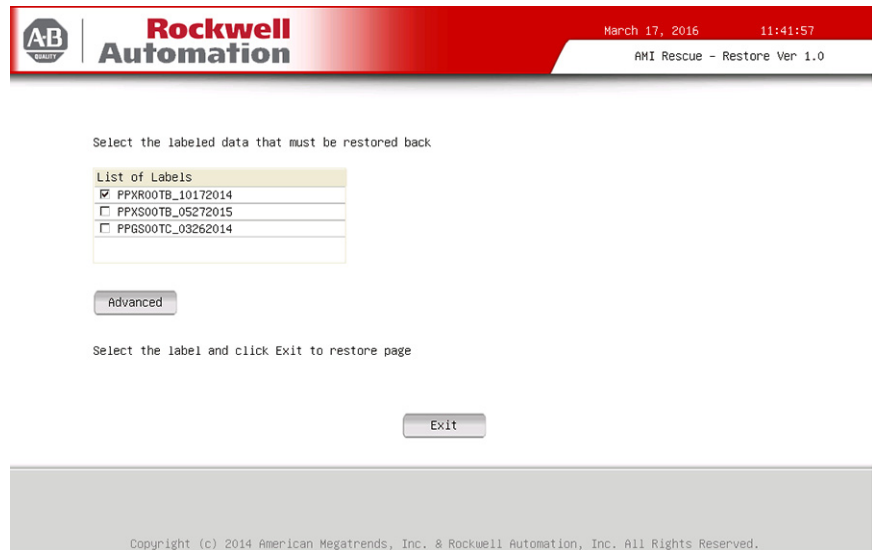

IMPORTANT If no labels are visible, then the backed-up OS image folder must be moved to the root directory of the USB storage drive. The backup is automatically assigned a name based on the system date, such as '03172016_00.'

- Click Advanced.
- On the Select Partition screen, select all boxes for Disk 0 so the entire OS image is restored.

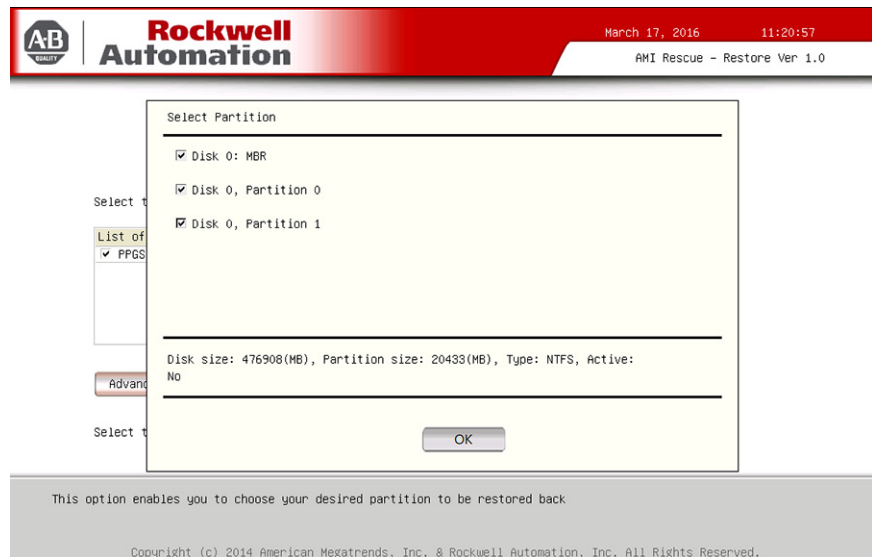

- Click OK.
- Click Exit.

- Click Restore Now to start the restoration process.

IMPORTANT The following warnings may appear:

The restored destination may not have enough space due to the compression rate of backup image. Continue?

No

If prompted, click Yes to continue.

Target partitions will be overwritten. Continue?

No

If prompted, click Yes to continue.

Do you want to keep the current partition table?

Yes

If prompted, click No to continue.

The current partition table will be restored to previous state. Continue?

No

If prompted, click Yes to continue.

Hardware History

You can view various hardware parameters from the Hardware History menu. It shows the total hours that the computer has been powered up, or runtime. It also displays the minimum and maximum temperatures (in °C) over the entire runtime.

All displayed values are read-only, and the time stamp is 24-hour clock.

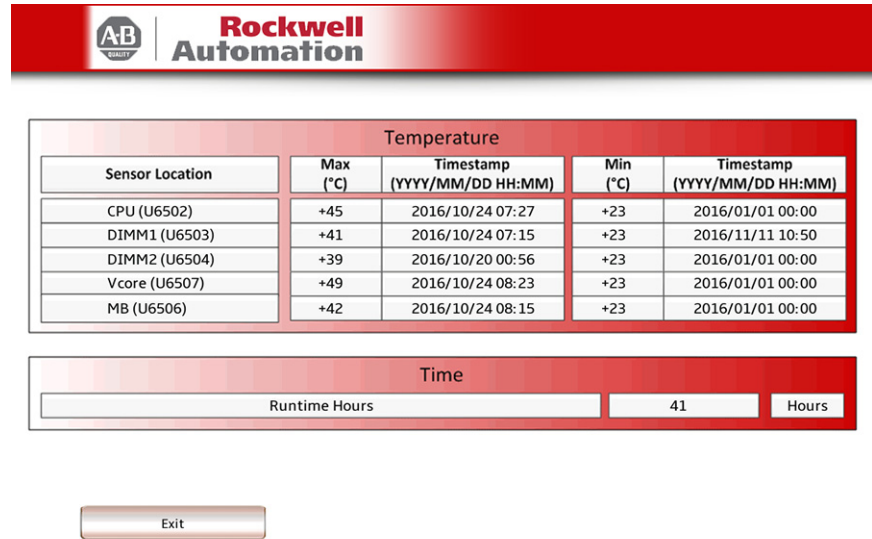

Menu	Description
CPU DIMM1 DIMM2 Vcore MB	Same hardware temperatures as identified in Hardware Monitor; for more information, see page 50 .
Runtime Hours	The total hours that the computer has been powered up. IMPORTANT: Make sure that all writes to the drive are complete before you remove the drive from the system to avoid the risk of data corruption.
Exit	Returns you to the main set-up screen; see page 42 .

Exit

Use the Exit menu to close the UEFI set-up utility.

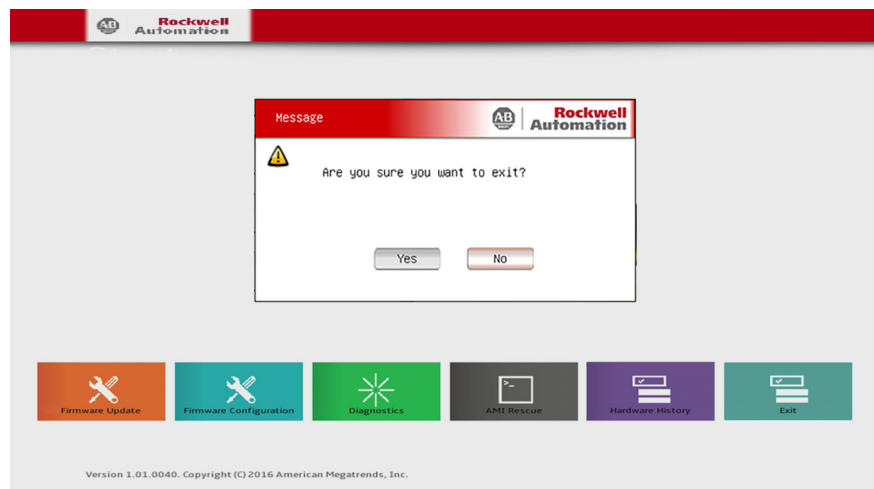
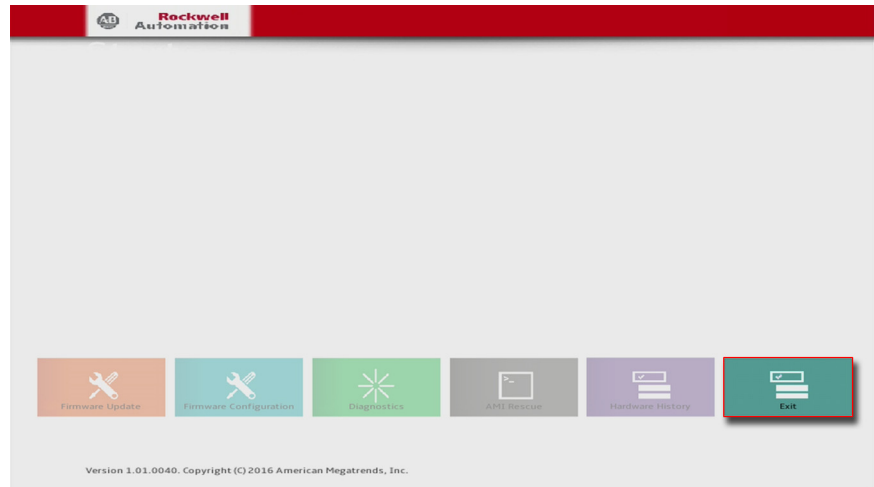

Upgrade to a New UEFI

Sometimes a new UEFI (BIOS) is released to enhance the performance of your computer or to correct a defect. In such cases, you can download BIOS upgrades at the Rockwell Automation Product Compatibility and Download Center (PCDC) website at <https://compatibility.rockwellautomation.com/Pages/home.aspx>. A USB flash drive upgrade is available.

Perform the following steps to upgrade to a new UEFI (BIOS).

1. Attach the following external peripherals to your computer:
 - Display (for non-display computers)
 - Keyboard
 - USB flash drive (1 GB or larger)
2. Access the Rockwell Automation PCDC website at <https://compatibility.rockwellautomation.com/Pages/home.aspx>.
3. On the home page, click Downloads.
4. On the Find Downloads page, use your computer model as the search criteria.
5. Follow the instructions on the PCDC site to find your BIOS.

TIP

You must be registered with the Rockwell Automation PCDC website to download files.

You must accept a User Agreement before files can be downloaded.

6. Download the BIOS file to your USB flash drive.
7. After the file downloads, restart the computer.
8. During POST, press F5.
9. Select Internal Shell.
10. Wait for 'startup.nsh' to load.
11. Follow the onscreen instructions to flash the system.

IMPORTANT

Do not interrupt power to the computer during the UEFI (BIOS) flash.

12. After the UEFI (BIOS) flash is complete, restart the computer.
13. During POST, press F2 to access the UEFI set-up utility.
14. On the Main tab, verify that the system time and date are accurate.
15. Press F10 to save your changes and to exit the UEFI set-up utility.

Troubleshoot the System

Topic	Page
Hardware Monitoring	67
Troubleshooting	68
Diagnostics	68
Load the System Defaults	69
Clear the CMOS	70
Ship or Transport the Computer	71
Dispose of the Computer	71

Hardware Monitoring

The built-in hardware monitor of the computer tracks the operating threshold levels of the voltage and temperature sensors.

Follow these steps to determine whether an operating threshold has been reached.

1. Shut down the computer by using the appropriate method for the installed operating system.

See [Shut Down the Computer on page 29](#) for more information.

2. Apply power to the computer.
3. During POST, press F2 to access the UEFI set-up utility.

TIP Use the arrow keys on a keyboard to navigate between UEFI menus and menu selections.

4. Select the Hardware Monitor menu from the Advanced menu.

Use this menu to determine if there is an issue with internal voltages or component temperatures.

See [Hardware Monitor on page 50](#) for more information.

Troubleshooting



WARNING: Before performing any maintenance procedures, review the safety information in [Hazardous Locations on page 16](#) for equipment used in hazardous locations.

Follow these steps to identify and isolate an issue with the computer.

1. Shut down the computer by using the appropriate method for the installed operating system.
See [Shut Down the Computer on page 29](#) for more information.
2. Disconnect power from the computer.
3. Disconnect all peripheral devices from the computer.
 - If a keyboard and mouse is used, verify that they are properly connected.
 - If an external display is used, verify that it is properly connected.
4. Connect power to the computer. During POST, one of three events occurs:
 - The computer completes the start-up process.
 - A nonfatal error occurs and the related error message is displayed.
 - A fatal error occurs and the start-up process ends.

If	Then
The computer starts	Reconnect all peripheral devices one at a time until the issue occurs.
The issue is with a specific software or driver	Reinstall the software or driver.
The issue is not related specifically to software, a driver, or a peripheral device	Proceed to Diagnostics on page 68 .

Diagnostics

If you completed the troubleshooting steps and issues remain, use the Diagnostics menu in the UEFI set-up utility to isolate the issue. Diagnostics tests computer components to determine the cause of a malfunction.

Press F2 during POST or press F10 at any time to access the UEFI set-up utility:

- F2 during POST accesses the main menu of the UEFI set-up utility.
Select Diagnostics on the main menu.
- F10 directly accesses the Diagnostics menu of the UEFI set-up utility.

See [Diagnostics on page 54](#) for more information.

Follow these steps to save diagnostic reports.

TIP Use the arrow keys on a keyboard to navigate between UEFI menus and menu selections.

1. Select Generate Report in the Options menu and press Enter.
2. Select Report destination and press Enter.
3. Select File and press Enter.
4. Select the device path to generate the log report and press Enter.

If you need to generate the report in the current file system, press Enter.

Otherwise, select Continue and press Enter.

5. Enter log file details (file name and heading) for the report.

The default file name is AMIDiag.LOG.

6. Set the report parameters, such as log errors, log test activities, log test start time, log test end time, log errors only, log errors only with time, Append to old log file, Log device info on fail, Log device info on abort.
7. To exit the submenu, Select Continue and press Enter.

You do not need to disconnect or move your computer to perform an initial diagnosis. The selected test affects the process, which can take as little as 5 minutes or as long as 8 hours. After Diagnostics has run, you can generate a report for analysis by a technical support representative, which expedites any necessary repair process.

Load the System Defaults

If the computer fails after changes in the set-up menus, load the system default settings to correct the error. These default settings have been selected to optimize computer performance.

Follow these steps to load the system defaults.

1. Restart the computer as specified in [Restart the Computer on page 29](#).
2. During POST, press F2 to access the UEFI set-up utility.

TIP Use the arrow keys on a keyboard to navigate between UEFI menus and menu selections.

3. Depending on your computer series, press or select the system defaults and exit the UEFI set-up utility.

6. Use a conductive tool (such as a screwdriver) to make contact between the two pins **for 10 seconds**.
7. Follow the steps for [Post-configuration on page 33](#).

IMPORTANT When you clear the CMOS, all UEFI settings return to their defaults. UEFI settings other than default must be reconfigured after clearing the CMOS.

8. During POST, press F2 to access the UEFI set-up utility and reconfigure settings.

Ship or Transport the Computer

If you must ship the computer via common carrier or otherwise transport it to another location for any reason, then you must first uninstall the computer and place it in its original packing material.



ATTENTION: Do not ship or transport the computer when it is installed in a machine, panel, or rack. Doing so can damage the computer. You must uninstall the computer and place it in its original packing material before shipping. Rockwell Automation is not responsible for any damage to a computer that is shipped or transported while installed in a machine, panel, or rack.

Dispose of the Computer



At the end of its life, the computer must be collected separately from any unsorted municipal waste.

You cannot dispose of computer equipment like other waste material. Most computers and monitors contain heavy metals that can contaminate the earth. Therefore, check with local health and sanitation agencies for ways to properly dispose of computer equipment.

When a storage drive is part of what you are disposing, then permanently erase any data on it or destroy the drive before it is disposed.

Notes:

Use a Touch Screen

Topic	Page
Touch Screen Technology	73
Driver Software	73
Resistive Touch Screen Technology	73
Calibrate the Touch Screen	74

Touch Screen Technology

Integrated display computers are shipped with the touch screen controller installed and connected. The touch screen controller connects internally to a USB port.

Driver Software

6181X-12A2S computers with an integrated display are shipped with the touch screen controller installed and connected. The touch screen controller connects internally to a USB port.

If you must reinstall the touch screen driver, it is available for download at the Rockwell Automation® Product Compatibility and Download Center (PCDC) at <https://compatibility.rockwellautomation.com/Pages/home.aspx>.

TIP If you must reinstall the touch screen driver, the touch screen utility automatically detects the USB port used by the touch screen controller.

Resistive Touch Screen Technology

Resistive touch screens are activated when you apply pressure to the touch screen with your finger. You can operate a resistive touch screen while gloves are worn.

IMPORTANT Operate the touch screen with a finger, gloved finger, or plastic stylus device with a minimum tip radius of 1.3 mm (0.051 in.) to help prevent damage to the touch screen.

Use with any other object or tool can damage the touch screen.



ATTENTION: Do not use sharp instruments to activate the touch screen, which can scratch the surface of the touch screen and damage the unit.

Calibrate the Touch Screen

The touch screen that is supplied with the computer is installed and calibrated at the factory.

Perform the following steps to recalibrate the touch screen.

1. Run the configuration utility for the touch screen.
Access the utility through the Programs menu of the operating system.
2. Start the calibration routine that is offered within the utility.
3. Follow the calibration instructions on the touch screen.

Maintain the Computer

Topic	Page
Clean the Computer	75
RTC Battery	76

Clean the Computer

It is important to maintain your computer. Periodically clean the display, heat sink and vent holes, and remove any grease or paint.

Clean the Integrated Display

Follow these steps to clean the display.

1. Disconnect power from the computer at the power source.



ATTENTION: If the computer has a touch screen, it is possible for screen objects to activate during equipment wash-downs if the computer is turned on.

2. Clean the display with a mild soap or detergent by using a clean sponge or a soft cloth.



ATTENTION: Do not use of abrasive cleansers or solvents, which can damage the display or touch screen. Do not scrub or use brushes.

3. Dry the display with a chamois or moist cellulose sponge to avoid water spots.

Clean the Heat Sink and Vent Holes

Follow these steps to clean the chassis.

1. Disconnect power from the computer at the power source.
2. Disconnect all peripheral devices from the computer.
3. Vacuum dust and debris from the heat sink and vent holes.

Remove Paint and Grease from the Bezel

Follow these steps to remove paint and grease from the bezel of computers that are properly mounted in NEMA Type 4/4X or IEC IP66 enclosures.

1. Remove paint splashes and grease by rubbing lightly with isopropyl alcohol.



ATTENTION: Verify that isopropyl alcohol does not come in contact with the equipment labels. Alcohol can cause the label print to smear.

2. Use a mild soap or detergent solution to remove residue.
3. Rinse with clean water.

RTC Battery

This computer contains a lithium battery that you cannot replace. Return the computer to Rockwell Automation for battery replacement.

For return information, contact your local distributor or Rockwell Automation representative, or visit <http://www.rockwellautomation.com/services/online-phone>.



The sealed lithium battery contained in this computer could need replacement during the life of the computer.

At the end of its life, collect the battery in this computer separately from any unsorted municipal waste.

A

accessories 31
add-in card 37

B

BIOS Setup utility
access 42
Setup screen 42

C

calibrating touch screen 74
cleaning the computer
chassis 75
display 75
paint/grease marks 76
clear CMOS 70
CMOS, clear 70
CompactFlash card 35, 36
installation 35, 36
component replacement
add-in card 37
CompactFlash card 35, 36
memory module 38
replacement parts 31
tools 33
voltage precaution 31

D

diagnostic utility
usage 54
dimensions 21
panel cutout 22
DIMM slots
install memory 39
display
cleaning precautions 75

E

European Union directive compliance 14

F

Firmware Configuration
Advanced 46
Boot 52
Chipset 51
Main 45
Save & Exit 53
Security 53

H

hardware
features 11
hardware diagnostics 67
hardware monitor 67
hazardous locations 16
hot surfaces 17
restricted access 17
safety guidelines 35, 36
hot surfaces 17

I

installation 13, 27
apply power 25
guidelines 19
mounting clearances 20
restricted access 19

M

maintenance
battery 39, 76
clean the computer 75
cleaning display 75
memory
installation guidelines 39
installation precautions 38
upgrading 38
memory module 38
mounting
clearances 20
non-display computer 24

O

operating guidelines 27
operator access 28

P

panel cutout dimensions 22

panel mounting
guidelines 22

parts list 13

PCI 37

power
applying 25
precautions 25
turn on 28
voltage precaution 31

Power On Self Test 28

product
catalog numbers 9
dimensions 21
front and side views 11
options 9

product dimensions 21

R

rear cover
install, performance/non-display 34
remove, performance/non-display 33

replace components
post-configuration procedure 33
pre-configuration procedure 32

replacement parts 31

restricted access 17

S

Setup menu
AMI Rescue 55
Diagnostics 54
Exit 65
Firmware Configuration 44
Firmware Update 43

system
defaults 69
turn on 28

T

touch screen
calibrating 74
type 73

touchscreen
driver software 73

troubleshooting
diagnostic utility 68
hardware monitor 67
load system defaults 69
problem
analysis 68
procedure 42

V

voltage precaution 31

Rockwell Automation Support

Use the following resources to access support information.

Technical Support Center	Knowledgebase Articles, How-to Videos, FAQs, Chat, User Forums, and Product Notification Updates.	https://rockwellautomation.custhelp.com/
Local Technical Support Phone Numbers	Locate the phone number for your country.	http://www.rockwellautomation.com/global/support/get-support-now.page
Direct Dial Codes	Find the Direct Dial Code for your product. Use the code to route your call directly to a technical support engineer.	http://www.rockwellautomation.com/global/support/direct-dial.page
Literature Library	Installation Instructions, Manuals, Brochures, and Technical Data.	http://www.rockwellautomation.com/global/literature-library/overview.page
Product Compatibility and Download Center (PCDC)	Get help determining how products interact, check features and capabilities, and find associated firmware.	https://compatibility.rockwellautomation.com/Pages/home.aspx

Documentation Feedback

Your comments will help us serve your documentation needs better. If you have any suggestions on how to improve this document, complete the How Are We Doing? form at http://literature.rockwellautomation.com/idc/groups/literature/documents/du/ra-du002_-en-e.pdf.

Rockwell Automation maintains current product environmental information on its website at <http://www.rockwellautomation.com/rockwellautomation/about-us/sustainability-ethics/product-environmental-compliance.page>.

Allen-Bradley, Rockwell Automation, and Rockwell Software are trademarks of Rockwell Automation, Inc.

Trademarks not belonging to Rockwell Automation are property of their respective companies.

Rockwell Otomasyon Ticaret A.Ş., Kar Plaza İş Merkezi E Blok Kat:6 34752 İçerenköy, İstanbul, Tel: +90 (216) 5698400

www.rockwellautomation.com

Power, Control and Information Solutions Headquarters

Americas: Rockwell Automation, 1201 South Second Street, Milwaukee, WI 53204-2496 USA, Tel: (1) 414.382.2000, Fax: (1) 414.382.4444

Europe/Middle East/Africa: Rockwell Automation NV, Pegasus Park, De Kleetlaan 12a, 1831 Diegem, Belgium, Tel: (32) 2 663 0600, Fax: (32) 2 663 0640

Asia Pacific: Rockwell Automation, Level 14, Core F, Cyberport 3, 100 Cyberport Road, Hong Kong, Tel: (852) 2887 4788, Fax: (852) 2508 1846